

LFX NEON SERIES 17 SPEC SHEET



LFX-N-17 -RGBW-48V



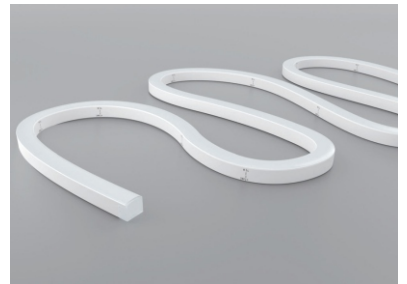

YYZ LFX Neon series is designed to provide a very bright, crisp consistent and homogenized illumination that will accentuate any building, structure, or artistic flourish. Using high brightness surface mounted LEDs, behind a first-class eco-friendly UV-resistant Silicone polymer encapsulated flexible chamber material, the LFX Neon will provide your project with bright, consistent traces of light in shades of White, single colors. The fixture consists of uniform and even lighting with no Led hotspot. LFX Neon has a transverse minimum radius of 75mm and is horizontal bendable. Easy to install, can be cut and reconnected with IP68 protected connector. The product is supplied in 5m standard rolls or custom as needed.



SPECIFICATION

OPERATING VOLTAGE	48V DC
POWER	20W / m
LED COUNT	84LEDs/m
CUTTING UNIT	14 LEDs
CUTTING LENGTH	166.7mm
MIN. BEND DIA.	150mm
LED SOURCE	SMD LED 5050
CCT	RGBW (2700K, 3000K, 4000K, 5000K)
MAX. RUN LENGTH	45.93ft / 14 m(Single Feed), 91.86ft / 28 m (Double Feed)
BEAM ANGLE	120°
LAMP LIFE	70, 000 hoursL70@25°C, 50, 000 hours L70@50°C
MATERIAL	Silicone
OPERATING TEMP	-40°C to +55°C
IP RATING	IP68
IK RATING	IK08
WARRANTY	5 years

-  **SMD LED 5050**
LED Quality
-  **48V DC**
Working Voltage
-  **20W/m**
Rated power

DELIVERED LUMENS BY CCT

Color	lm / m
Red	49lm/m
Green	182lm/m
Blue	32lm/m
RGB(White)	463lm/m
3000K	209lm/m

DIMENSION

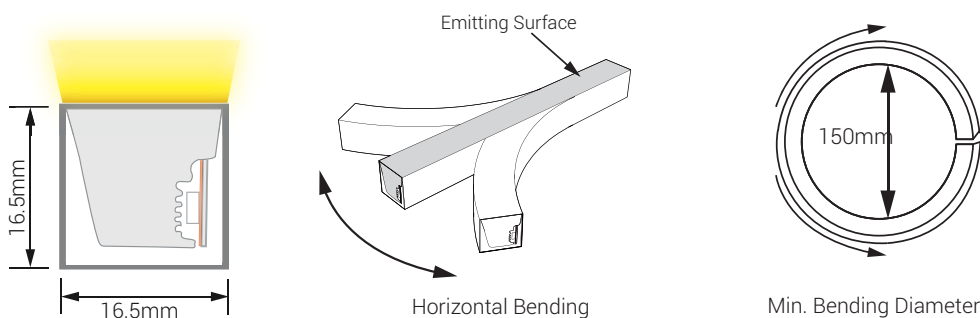

LFX NEON SERIES 17 SPEC SHEET

LFX-N-17 -RGBW-48V

CONNECTION DIAGRAM

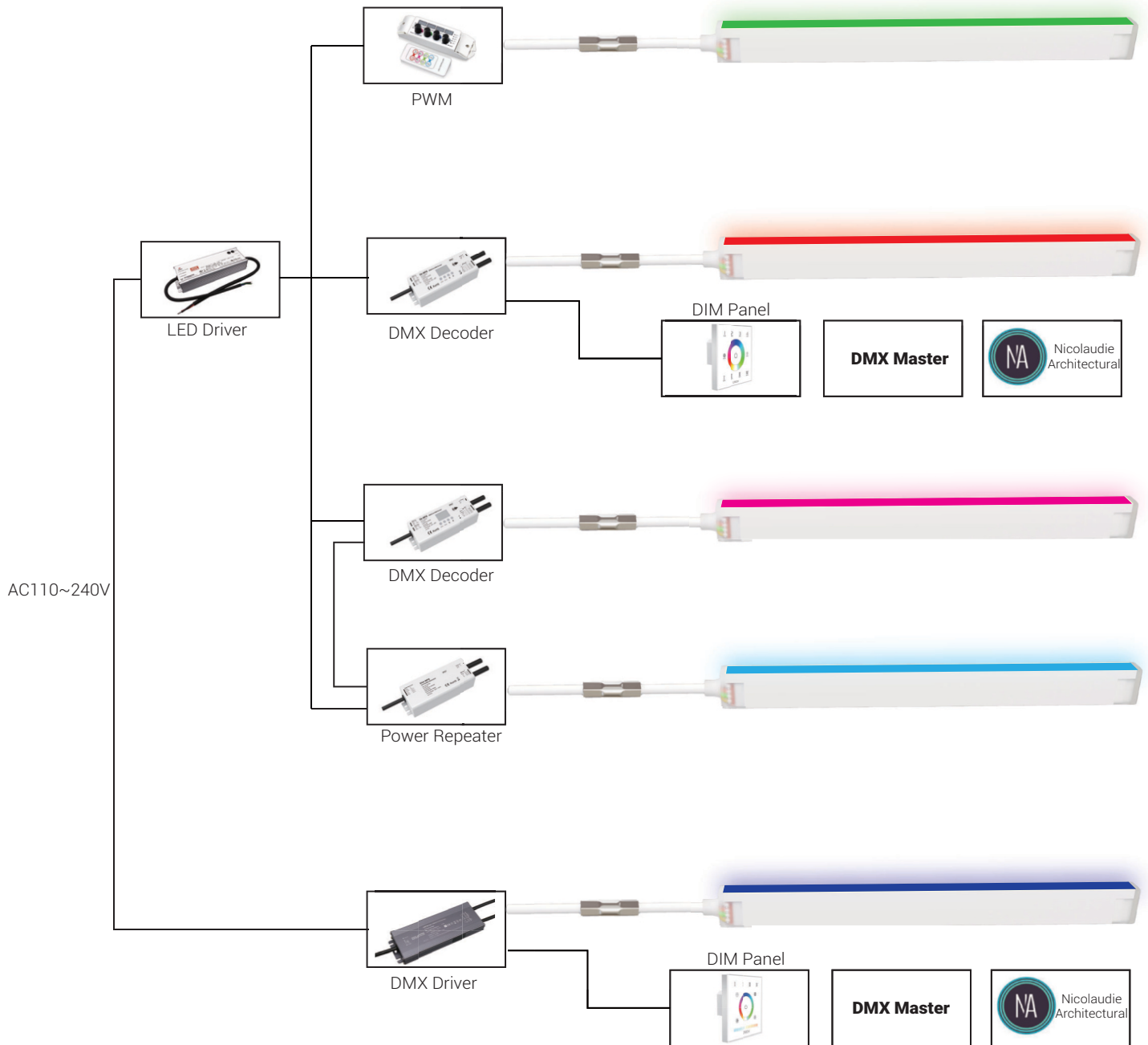

LFX NEON SERIES 17 SPEC SHEET



LFX-N-17 -RGBW-48V

ORDERING CODE

PRODUCT	TYPE	MODEL	BENDING	POWER	VOLTAGE	COLOR	CONTROL
LFX	N - Neon	17 - 17	HB - Horizontal Bending	20 - 20W	DC - 48V DC	RGB+27 - RGBW(2700K) RGB+30 - RGBW(3000K) RGB+40 - RGBW(4000K) RGB+50 - RGBW(5000K)	SW - Switch DALI - DALI DMX - DMX DIM - 0/1-10V TRI - TRIAC

Sample: LFX-N-17-HB-20-DC-RGB+27-SW

PHOTOMETRIC DATA

Illuminance Distribution

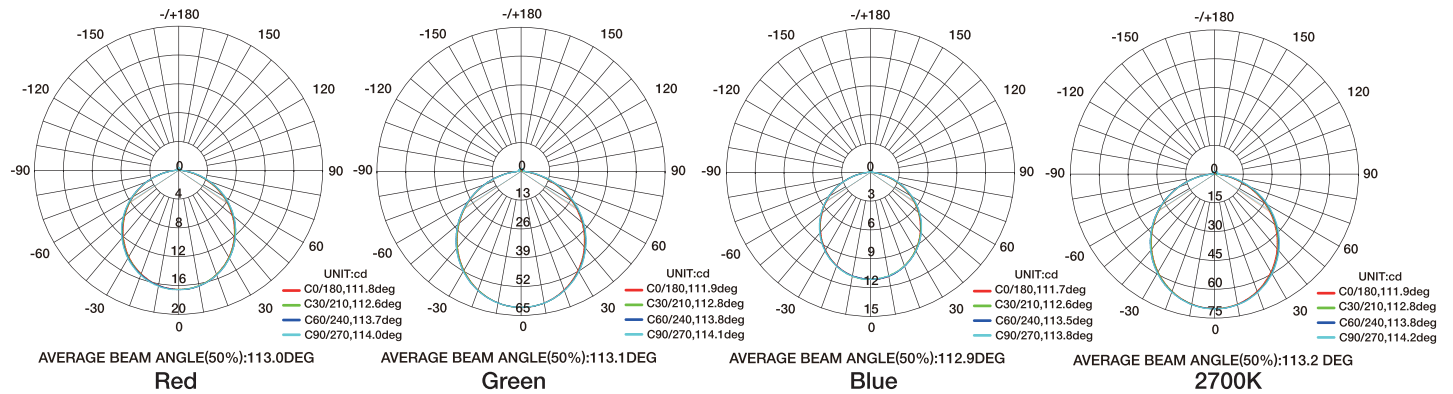

ACCESSORIES

MOLD INJECTION CONNECTOR (IP68 Factory Assembly Only)

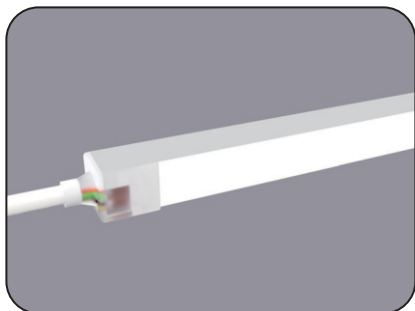

Direct Entry Connector
 MJ-LFX17-RGBW-D01/02/03
 MJ-LFX17-RGBW-D01SM
 MJ-LFX17-RGBW-D02SF
 MJ-LFX17-RGBW-D03SFM

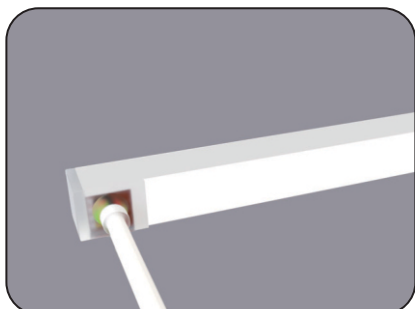
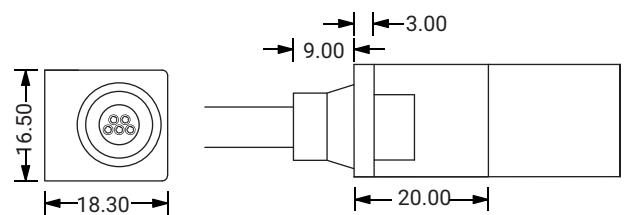

Side Entry Connector
 MJ-LFX17-RGBW-S01/02/03
 MJ-LFX17-RGBW-S01SM
 MJ-LFX17-RGBW-S02SF
 MJ-LFX17-RGBW-S03SFM

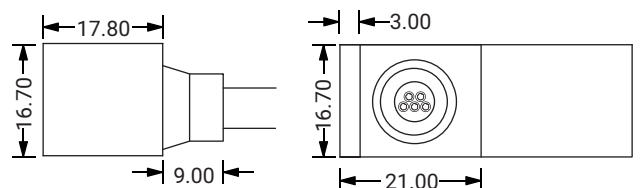

LFX NEON SERIES 17 SPEC SHEET

LFX-N-17 -RGBW-48V

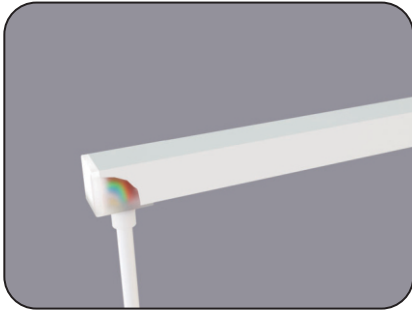

Bottom Entry Connector
MJ-LFX17-RGBW-B01/02/03
MJ-LFX17-RGBW-B01SM
MJ-LFX17-RGBW-B02SF
MJ-LFX17-RGBW-B03SFM

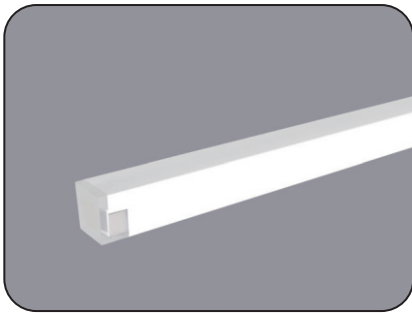
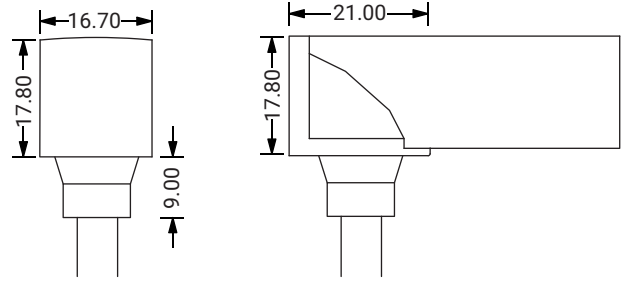

End Cap

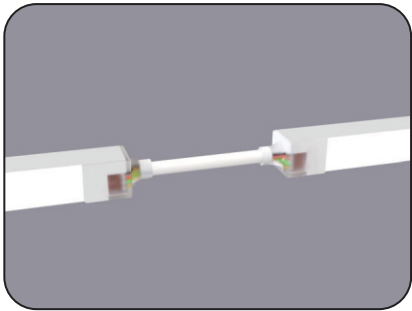
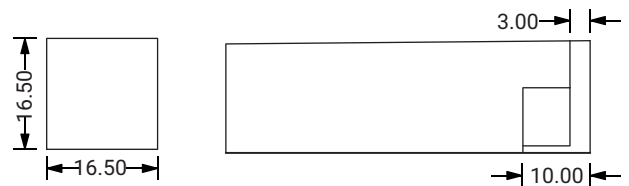

Jumper
MJ-LFX17-RGBW-D-JC

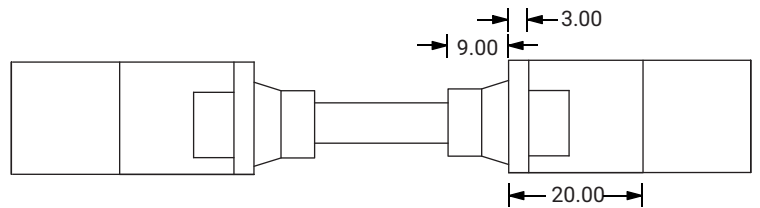

DIY Snap End Cap
DIY-SN-END-17-D-01/02

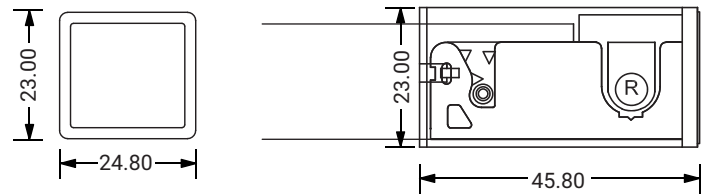

DIY Screw End Cap
DIY-SC-END-16

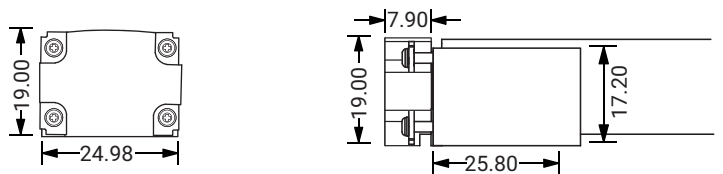

LFX NEON SERIES 17 SPEC SHEET

LFX-N-17 -RGBW-48V

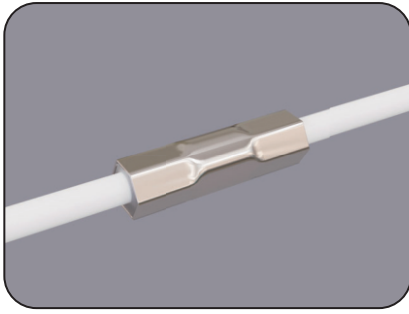

Waterproof Interrupter

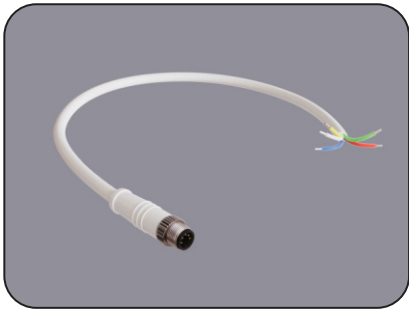
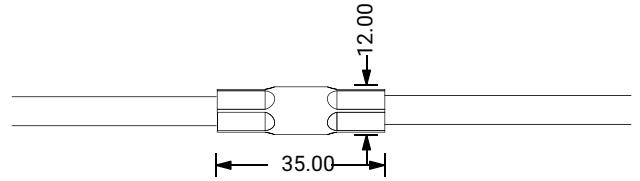

Male Connector
M12-M-5C-22AWG-D6-W-0327-S

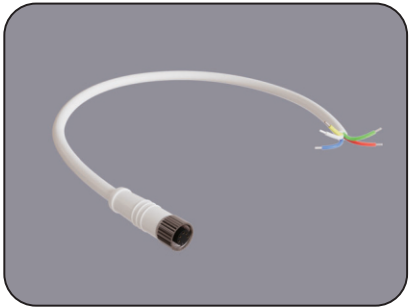
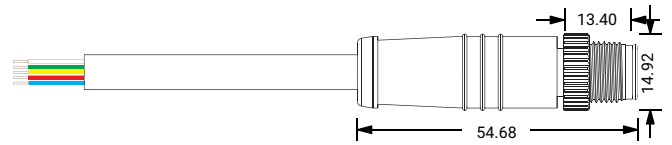

Female Connector
M12-F-5C-22AWG-D6-W-0327-S

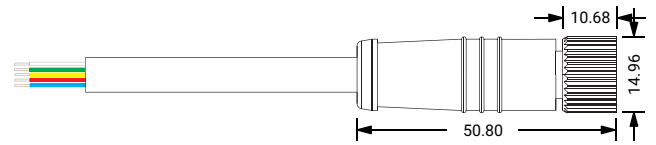

Male Connector End Cap
SYZ-EC-M12-M

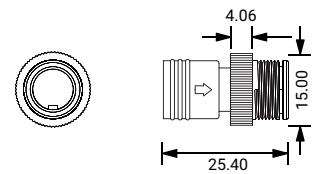

Female Connector End Cap
SYZ-EC-M12-F-5C

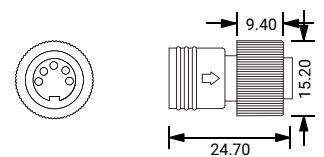

LFX NEON SERIES 17 SPEC SHEET

LFX-N-17 -RGBW-48V



ALUMINUM CHANNEL

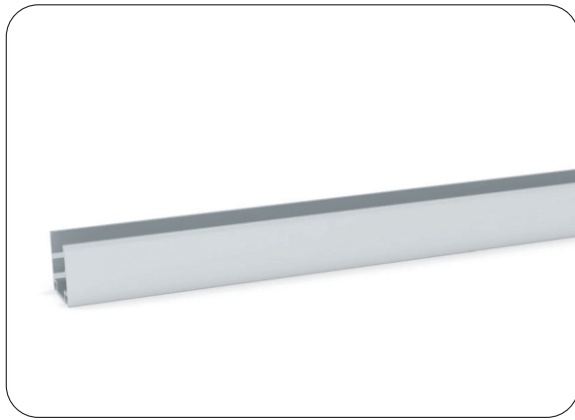

Dimension

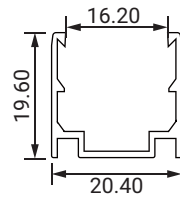

Installation Way

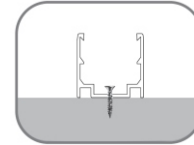

Surface Mounted

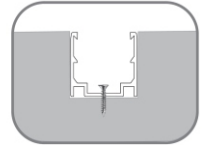

Recessed

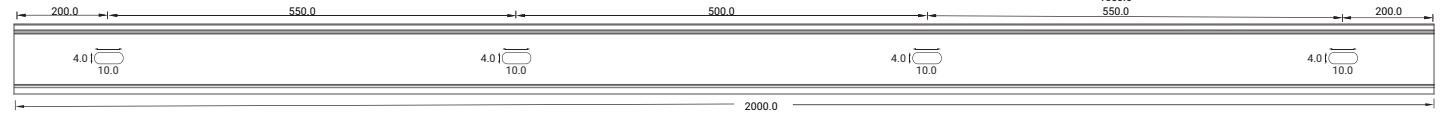
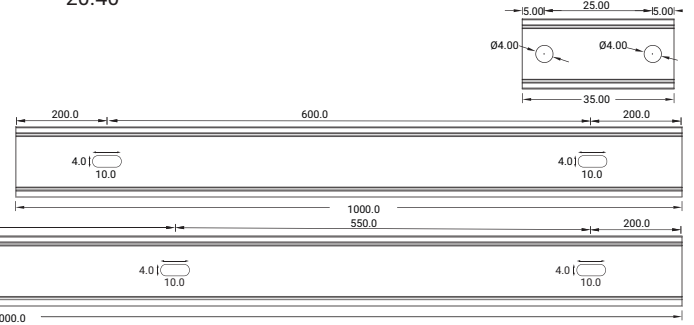

Model	W x H (mm)	Standard Length	Screw Holes	Holes Numbers
ALC16S02-035	20.40 x 19.60	35mm	Ø4.00mm	2
ALC16S02-100		1000mm	4.00mm	2
ALC16S02-200		2000mm	4.00mm	4



Dimension

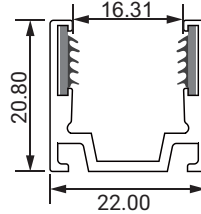

Installation Way

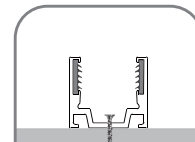

Surface Mounted

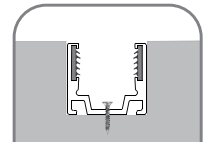

Recessed

Splice Accessories

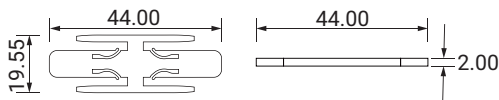
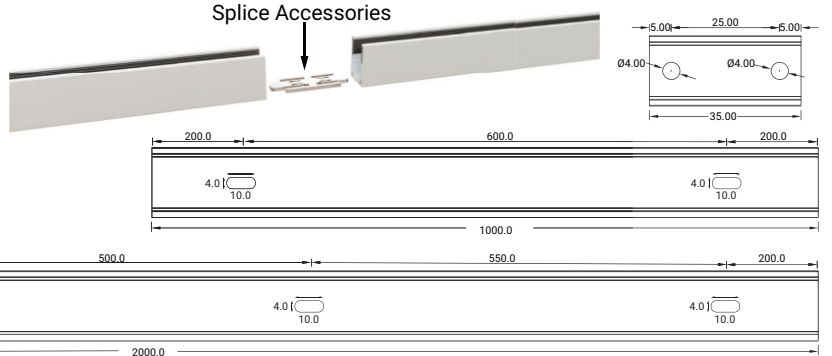

Splice Accessories: ALC16S08-SP

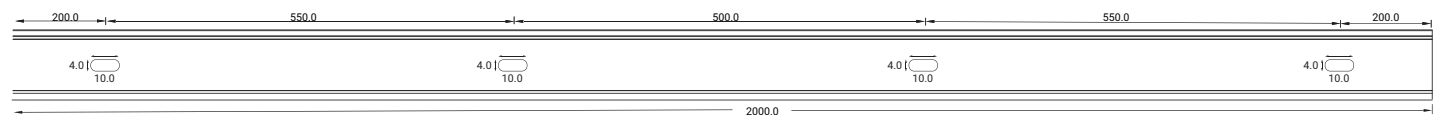

Model	W x H (mm)	Standard Length	Screw Holes	Holes Numbers
ALC16S08-035	22.00 x 20.80	35mm	Ø4.00mm	2
ALC16S08-100		1000mm	4.00mm	2
ALC16S08-200		2000mm	4.00mm	4

LFX NEON SERIES 17 SPEC SHEET

LFX-N-17 -RGBW-48V

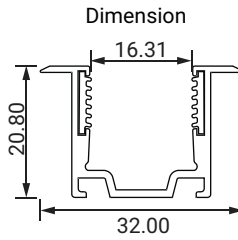
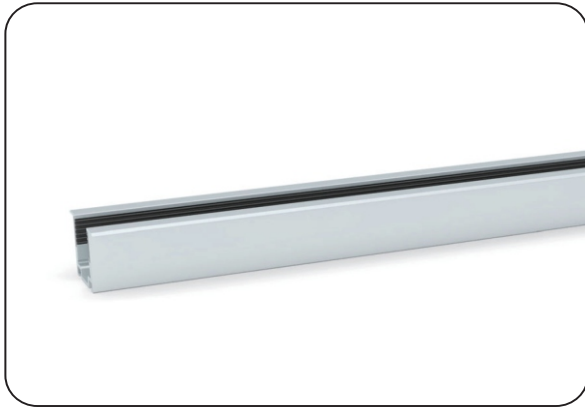

Installation Way

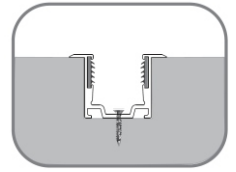

Recessed

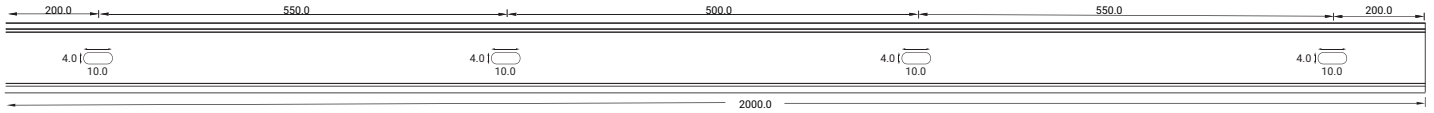
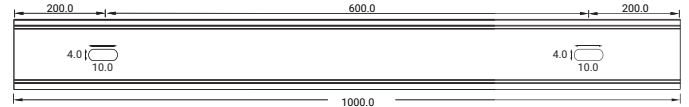
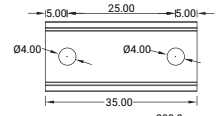

Model	W x H (mm)	Standard Length	Screw Holes	Holes Numbers
ALC16S07-035	32.00 x 20.80	35mm	Ø4.00mm	2
ALC16S07-100		1000mm	4.00mm	2
ALC16S07-200		2000mm	4.00mm	4

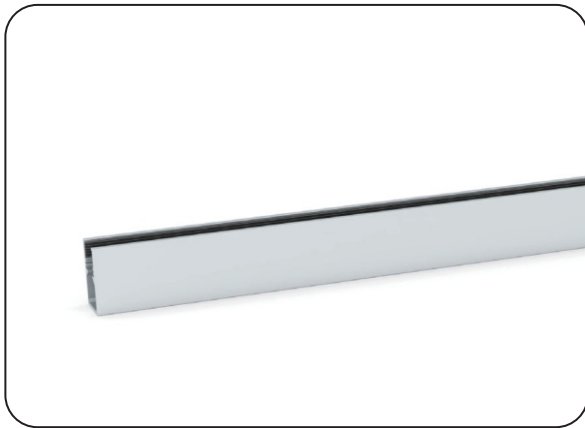

Dimension

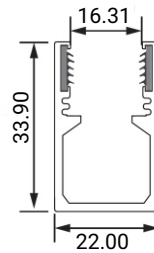

Installation Way

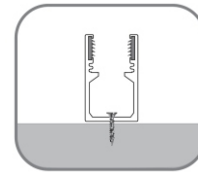

Surface Mounted

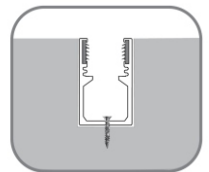

Recessed

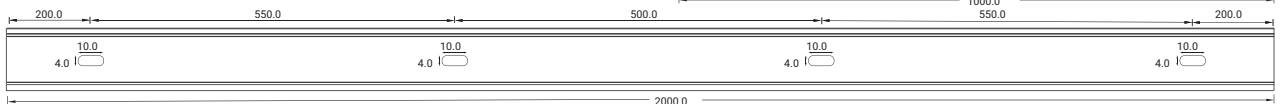
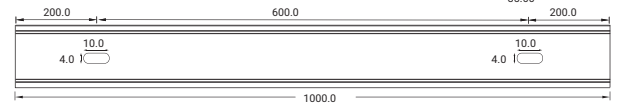
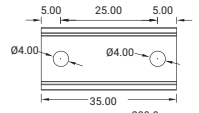

Model	W x H (mm)	Standard Length	Screw Holes	Holes Numbers
ALC16H02-035	22.00 x 33.90	35mm	Ø4.00mm	2
ALC16H02-100		1000mm	4.00mm	2
ALC16H02-200		2000mm	4.00mm	4

LFX NEON SERIES 17 SPEC SHEET

LFX-N-17 -RGBW-48V



FLEXIBLE ALUMINUM CHANNEL

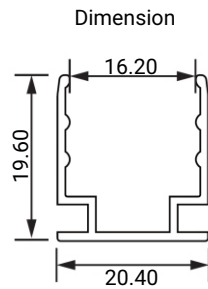
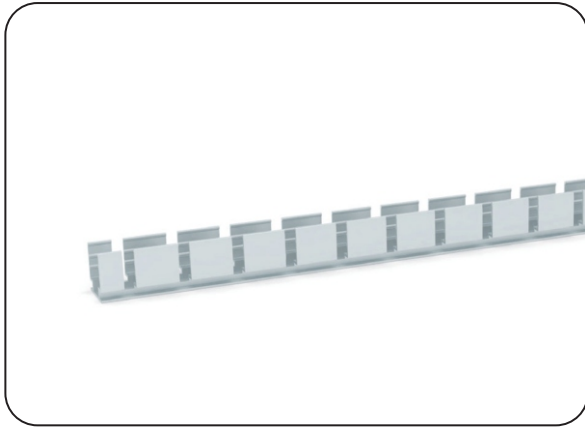

Installation Way

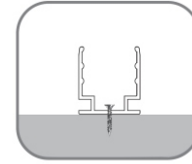

Surface Mounted

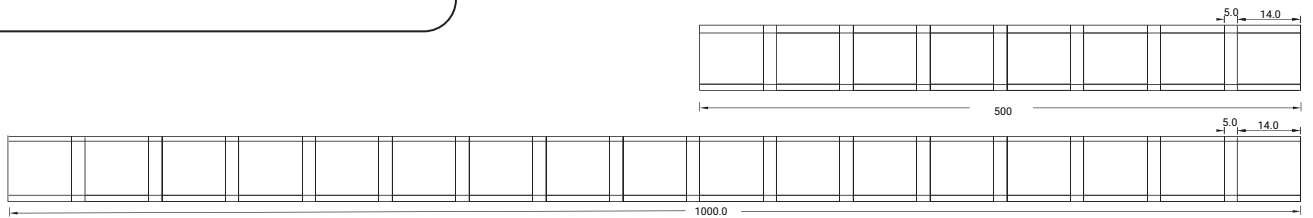

Model	W x H (mm)	Standard Length
ALC17S02FLX05	20.40 x 19.60	500mm
ALC17S02FLX10		1000mm

PLASTIC CHANNEL

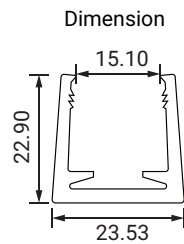

Installation Way

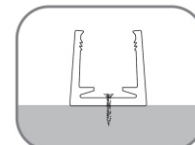

Surface Mounted

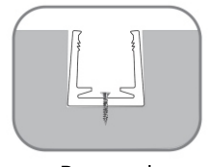

Recessed

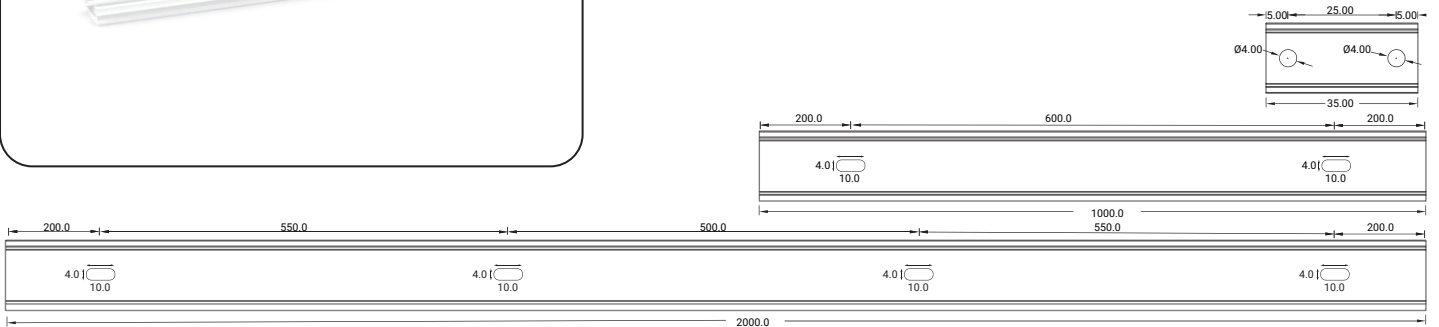

Model	W x H (mm)	Standard Length	Screw Holes	Holes Numbers
PC16/17S02-T-100	23.53 x 22.90	1000mm	Ø4.0mm	2

LFX NEON SERIES 17 SPEC SHEET

LFX-N-17 -RGBW-48V

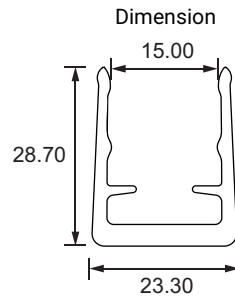

Installation Way

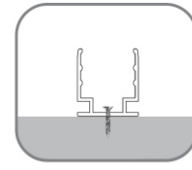

Surface Mounted

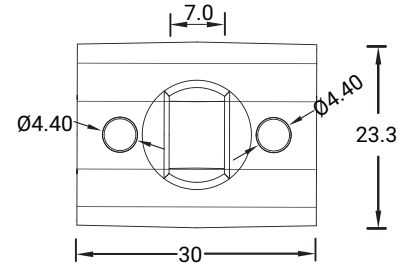

Model	W x H (mm)	Standard Length	Screw Holes	Holes Numbers
SJJ-ZSH-008-PC	23.30 x 28.70	30mm	Ø4.40mm	2

STAINLESS STEEL CHANNEL

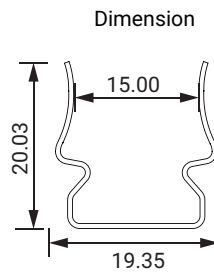
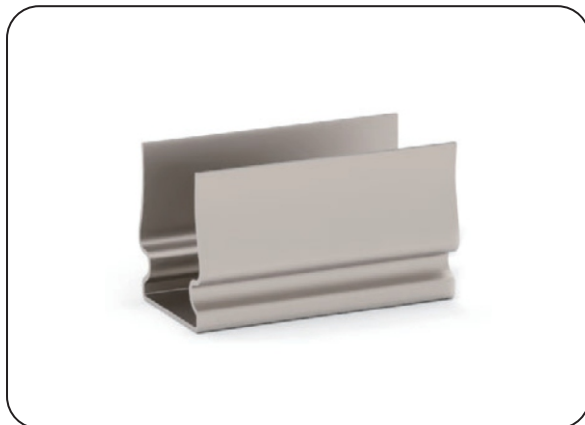

Installation Way

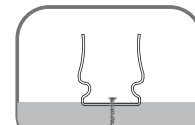

Surface Mounted

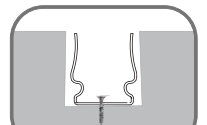

Recessed

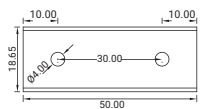

Model	W x H (mm)	Standard Length	Screw Holes	Holes Numbers
SSC16S01-05	19.35 x 20.03	50mm	Ø4.0mm	2

LFX NEON SERIES 17 SPEC SHEET

LFX-N-17 -RGBW-48V

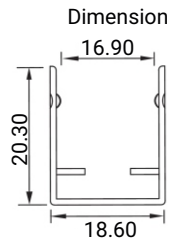
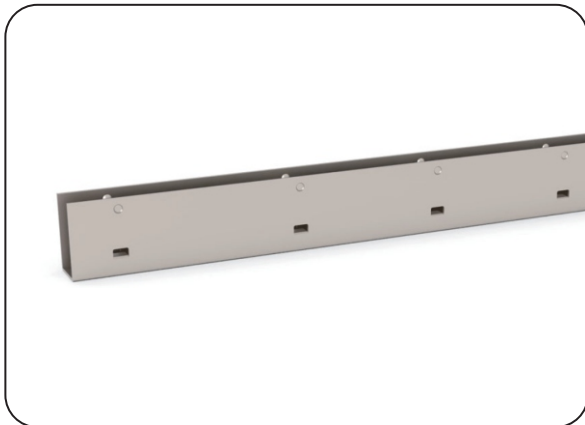

Installation Way

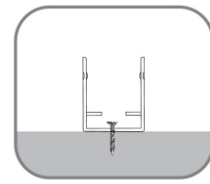

Surface Mounted

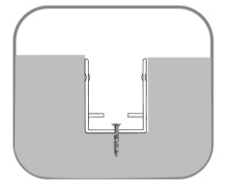

Recessed

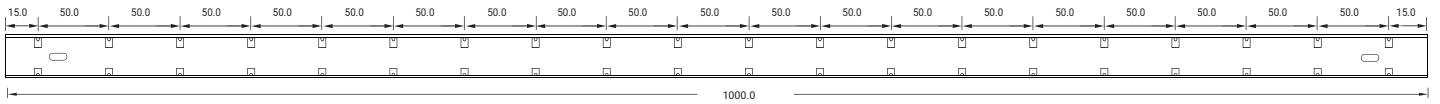

Model	W x H (mm)	Standard Length	Screw Holes	Holes Numbers
SSC16S02-100	18.60 x 20.30	1000mm	4.0 x 10mm	2

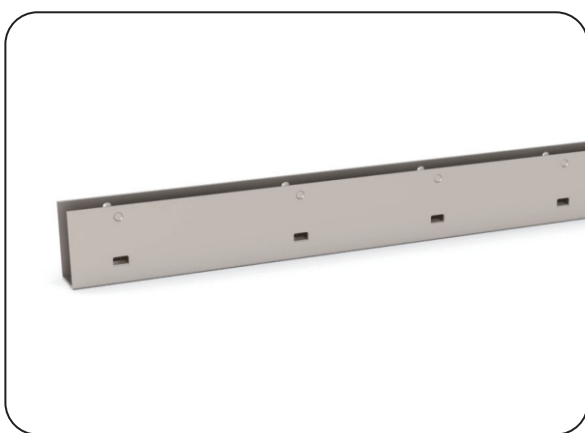

Dimension

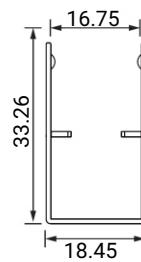

Installation Way

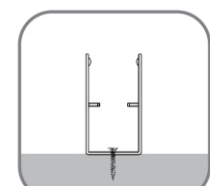

Surface Mounted

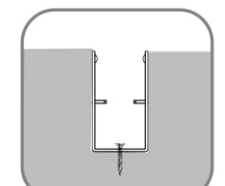

Recessed

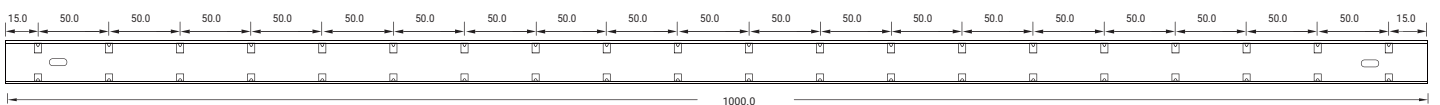

Model	W x H (mm)	Standard Length	Screw Holes	Holes Numbers
SSC16H01-100	18.45 x 33.26	1000mm	4.0 x 10mm	2

LFX NEON SERIES 17 SPEC SHEET

LFX-N-17 -RGBW-48V

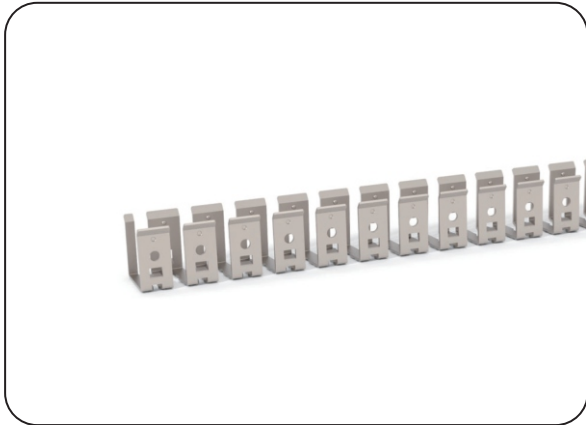

Dimension

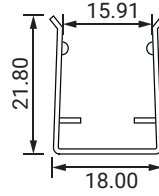

Installation Way

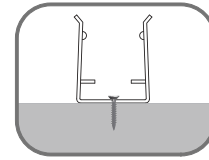

Surface Mounted

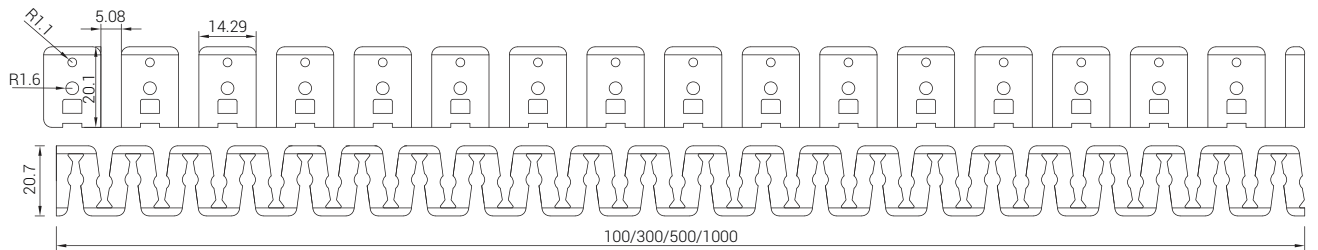

Model	W x H (mm)	Standard Length
SSC16FLX01	18.00 x 21.80	100mm
SSC16FLX03		300mm
SSC16FLX05		500mm
SSC16FLX10		1000mm