

# LFX NEON SERIES 17 SPEC SHEET



LFX-N-17 -MONO-24V



YYZ LFX Neon series is designed to provide a very bright, crisp consistent and homogenized illumination that will accentuate any building, structure, or artistic flourish. Using high brightness surface mounted LEDs, behind a first-class eco-friendly UV-resistant Silicone polymer encapsulated flexible chamber material, the LFX Neon will provide your project with bright, consistent traces of light in shades of White, single colors. The fixture consists of uniform and even lighting with no Led hotspot. LFX Neon has a transverse minimum radius of 75mm and is horizontal bendable. Easy to install, can be cut and reconnected with IP68 protected connector. The product is supplied in 5m standard rolls or custom as needed.

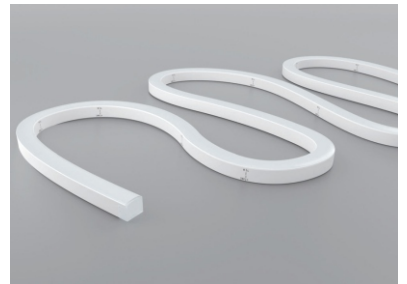

## SPECIFICATION

OPERATING VOLTAGE	24V DC
POWER	10W / m
LED COUNT	120LEDs/m
CUTTING UNIT	12 LEDs
CUTTING LENGTH	100 mm
MIN. BEND DIA.	150mm
LED SOURCE	SMD LED 2835
CCT	2200K, 2700K, 3000K, 3500K, 4000K, 4500K, 5000K, 6500K, Green, Blue, Red
CRI	80, 90
MAX. RUN LENGTH	32.80ft / 10 m(Single Feed), 65.61 ft / 20 m (Double Feed)
BEAM ANGLE	120°
LAMP LIFE	70, 000 hoursL70@25°C, 50, 000 hours L70@50°C
MATERIAL	Silicone
OPERATING TEMP	-40°C to +55°C
IP RATING	IP68
IK RATING	IK08
WARRANTY	5 years

-  **SMD LED 2835**  
LED Quality
-  **24V DC**  
Working Voltage
-  **10W/m**  
Rated power

## DELIVERED LUMENS BY CCT

Color	lm / m
2200K	350lm/m
2700K	400lm/m
3000K	389lm/m
3500K	394lm/m
4000K	411lm/m
4500K	500lm/m
5000K	407lm/m
6500K	399lm/m
Green	290lm/m
Blue	51lm/m
Red	122lm/m

## DIMENSION

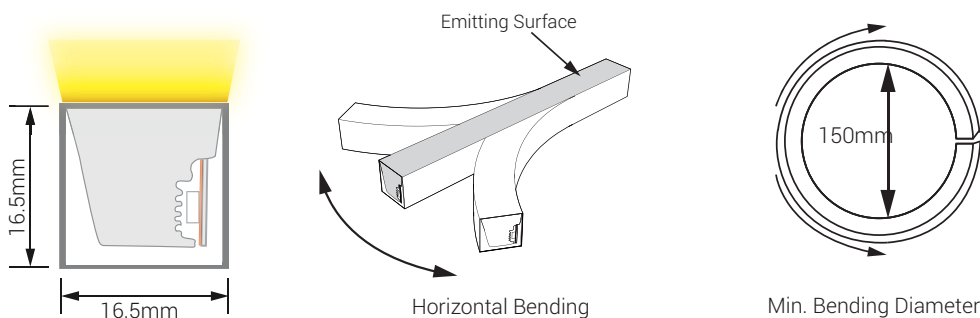

# LFX NEON SERIES 17 SPEC SHEET

LFX-N-17 -MONO-24V

## CONNECTION DIAGRAM

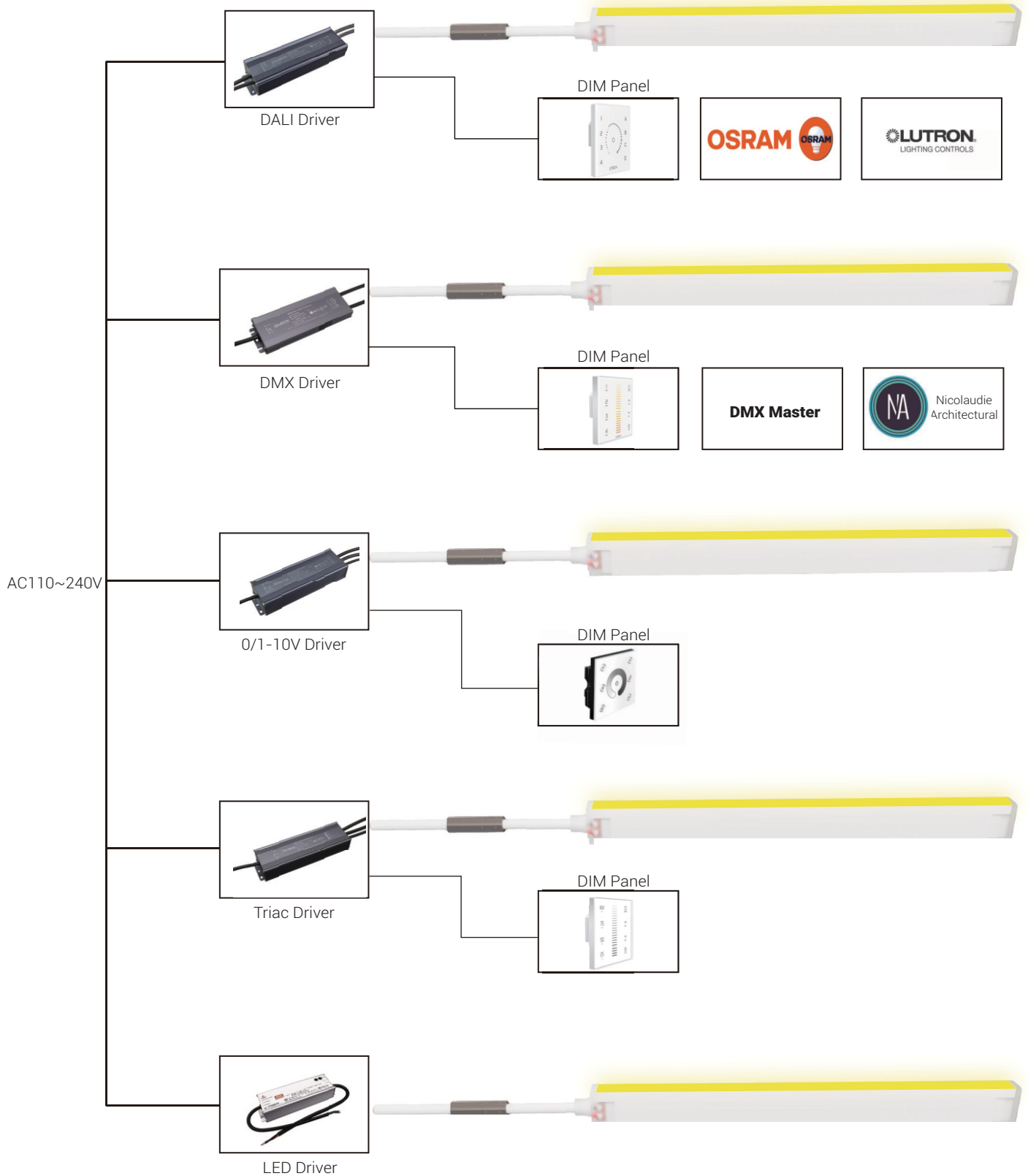

# LFX NEON SERIES 17 SPEC SHEET

LFX-N-17 -MONO-24V



## ORDERING CODE

PRODUCT	TYPE	MODEL	BENDING	POWER	VOLTAGE	CRI	COLOR	CONTROL
LFX	N - Neon	17 - 17	HB - Horizontal Bending	10 - 10W	DC - 24V DC	80 - 80 CRI 90 - 90 CRI	CT 22 - 2200K CT 27 - 2700K CT 30 - 3000K CT 35 - 3500K CT 40 - 4000K CT 45 - 4500K CT 50 - 5000K CT 65 - 6500K GR - Green BL - Blue RE - Red	SW - Switch DALI - DALI DMX - DMX DIM - 0/1-10V TRI - TRIAC

Sample: LFX-N-17-HB-10-DC-80-CT22-SW

## PHOTOMETRIC DATA

### Illuminance Distribution

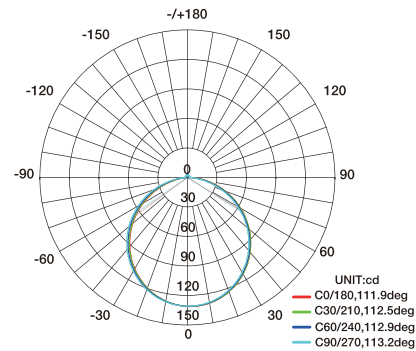

AVERAGE BEAM ANGLE(50%):112.6DEG

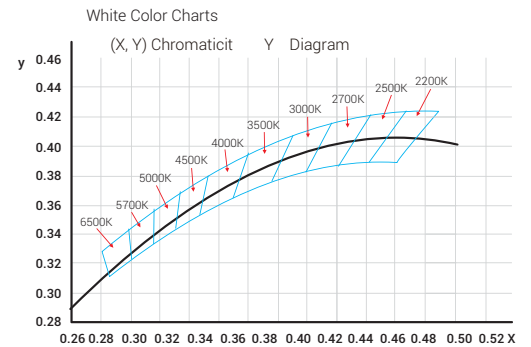
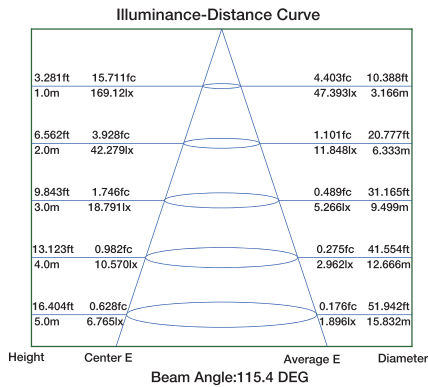

## ACCESSORIES

MOLD INJECTION CONNECTOR (IP68 Factory Assembly Only)

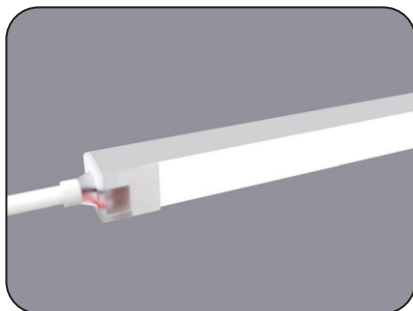

Direct Entry Connector  
 MJ-LFX17-A-D01/02/03  
 MJ-LFX17-A-D01SM  
 MJ-LFX17-A-D02SF  
 MJ-LFX17-A-D03SFM

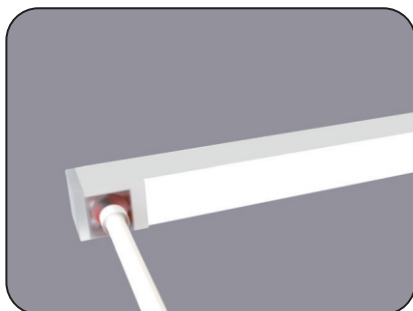
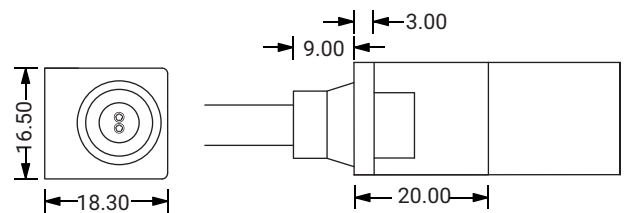

Side Entry Connector  
 MJ-LFX17-A-S01/02/03  
 MJ-LFX17-A-S01SM  
 MJ-LFX17-A-S02SF  
 MJ-LFX17-A-S03SFM

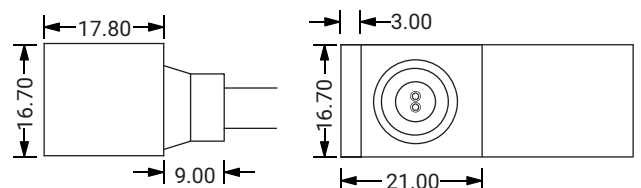

# LFX NEON SERIES 17 SPEC SHEET

LFX-N-17 -MONO-24V



Bottom Entry Connector  
MJ-LFX17-A-B01/02/03  
MJ-LFX17-A-B01SM  
MJ-LFX17-A-B02SF  
MJ-LFX17-A-B03SFM

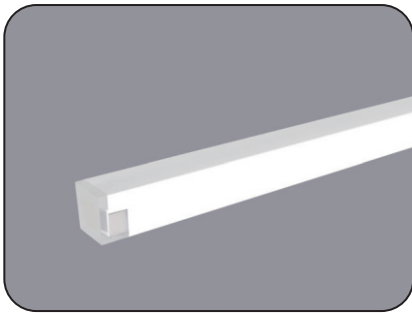
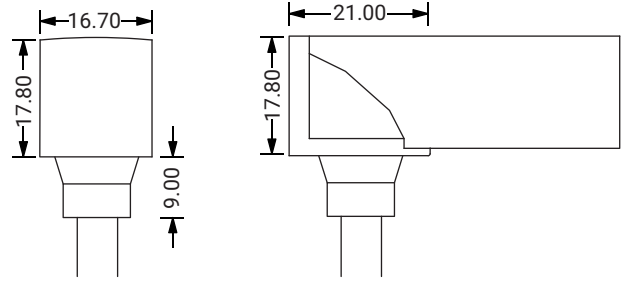

End Cap

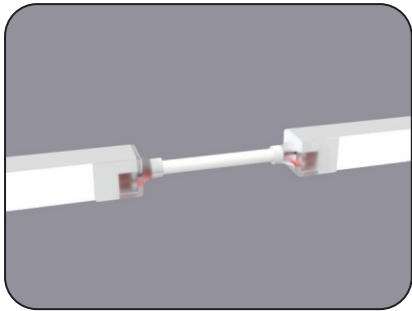
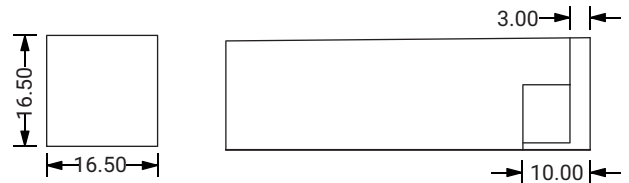

Jumper  
MJ-LFX17-D5-D-JC

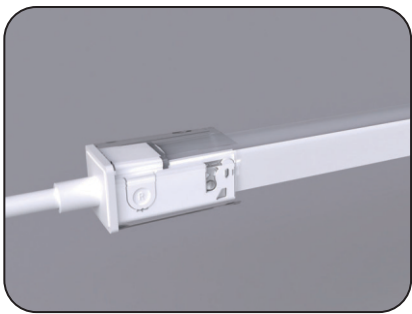
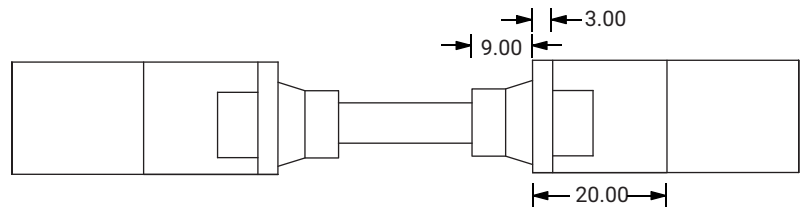

DIY Snap Connector  
DIY-SN-FR-17-D-01/02-A

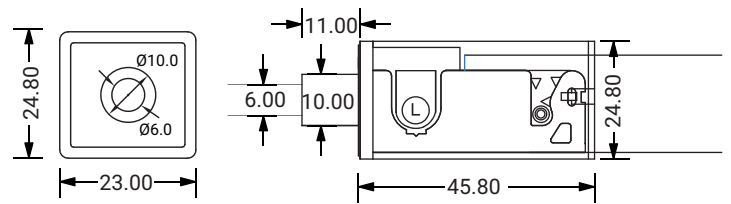

DIY Snap End Cap  
DIY-SN-END-17-D-01/02

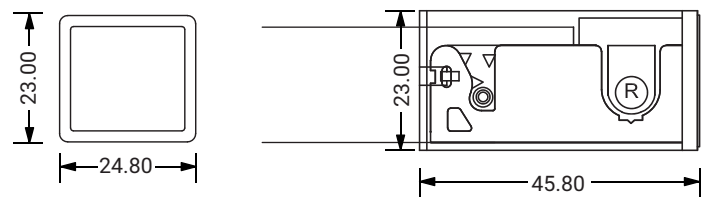

# LFX NEON SERIES 17 SPEC SHEET

LFX-N-17 -MONO-24V

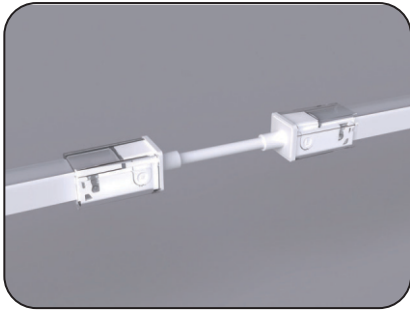

DIY Snap Extent Connector  
DIY-SN-EXT-17-A

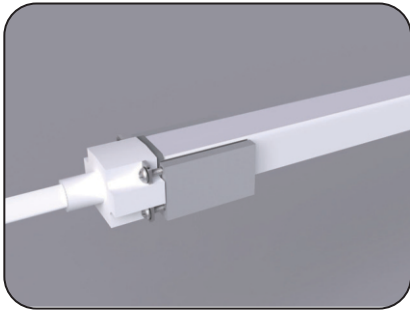
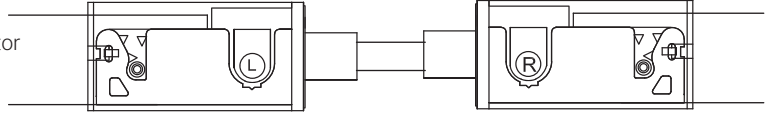

DIY Screw Connector  
DIY-SC-FR-17-D-01/02-A

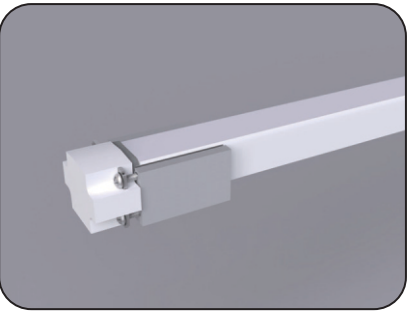
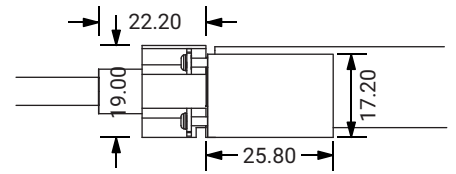
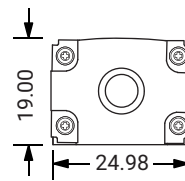

DIY Screw End Cap  
DIY-SC-END-17

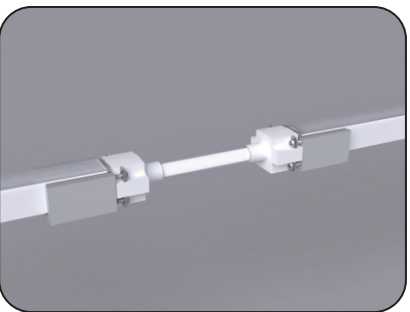
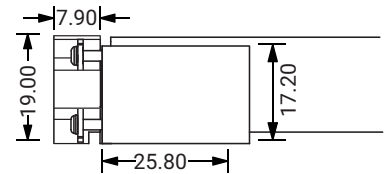
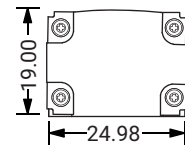

DIY Screw Extent Connector  
DIY-SC-EXT-16-A

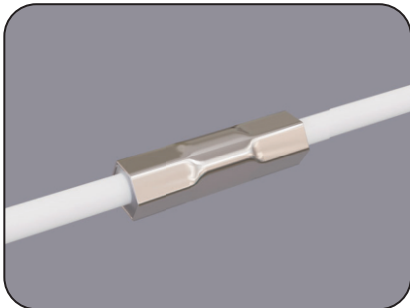
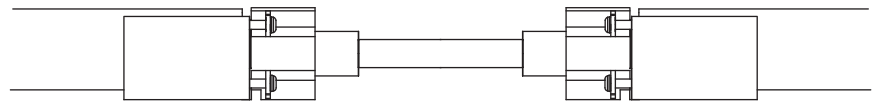

Waterproof Interrupter

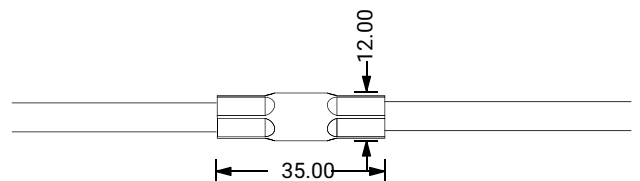

# LFX NEON SERIES 17 SPEC SHEET

LFX-N-17 -MONO-24V



Male Connector  
M12-M-2C-18AWG-D6-W-0327-S

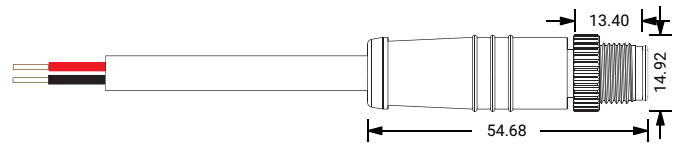

Female Connector  
M12-F-2C-18AWG-D6-W-0327-S

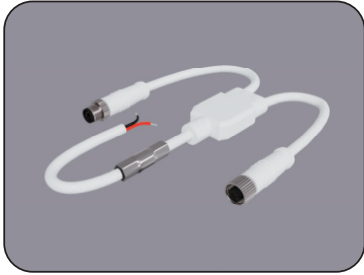
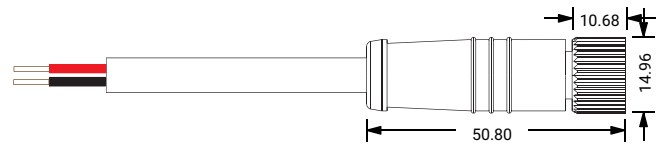

Middle Power Connector (1 to 2)  
MID-CNR-512C3-1T2

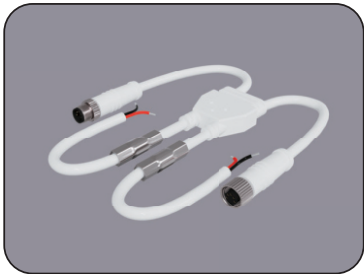
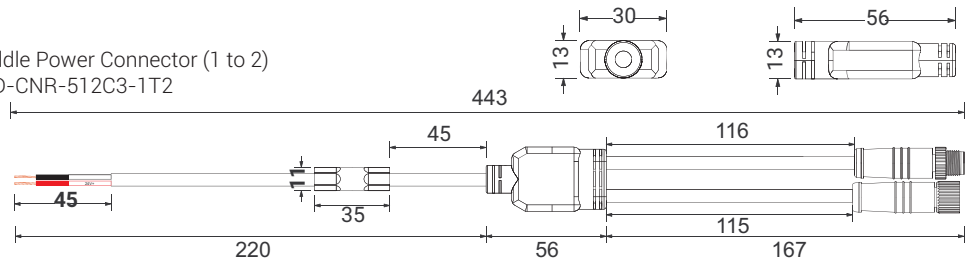

Middle Power Connector (2 to 2)  
MID-CNR-512C3-2T2

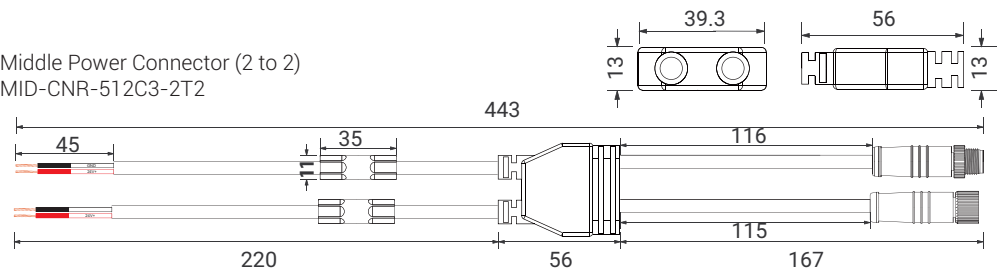

Male Connector End Cap  
SYZ-EC-M12-M

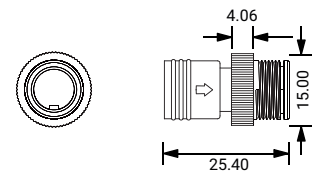

Female Connector End Cap  
SYZ-EC-M12-F-2C

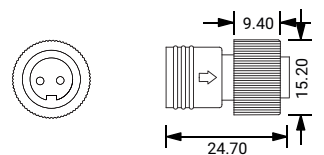

# LFX NEON SERIES 17 SPEC SHEET

LFX-N-17 -MONO-24V



## ALUMINUM CHANNEL

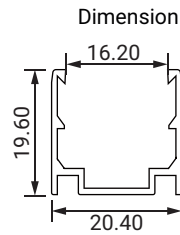
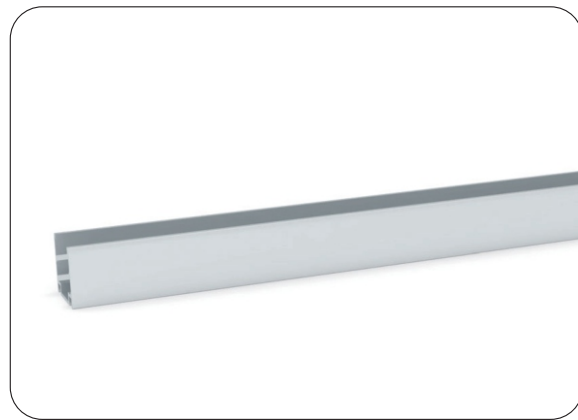

**Installation Way**

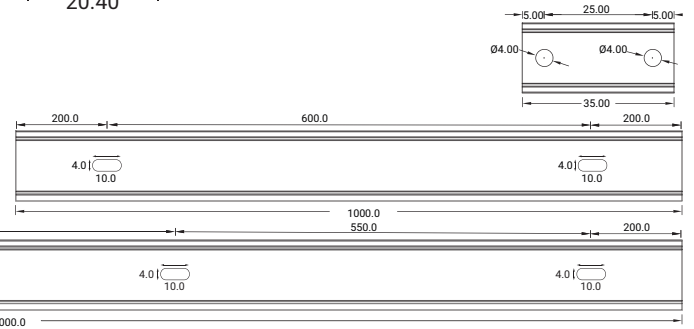
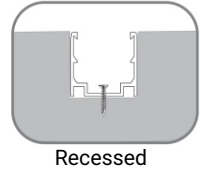
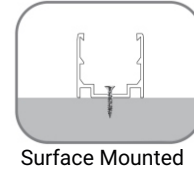

Model	W x H (mm)	Standard Length	Screw Holes	Holes Numbers
ALC16S02-035	20.40 x 19.60	35mm	Ø4.00mm	2
ALC16S02-100		1000mm	4.00mm	2
ALC16S02-200		2000mm	4.00mm	4

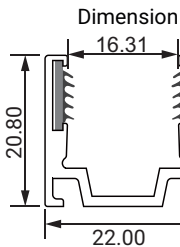

**Installation Way**

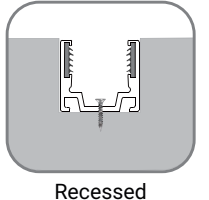
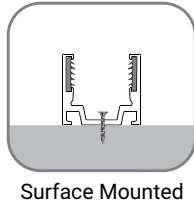

**Splice Accessories**

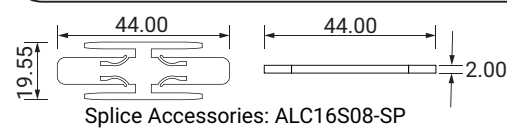
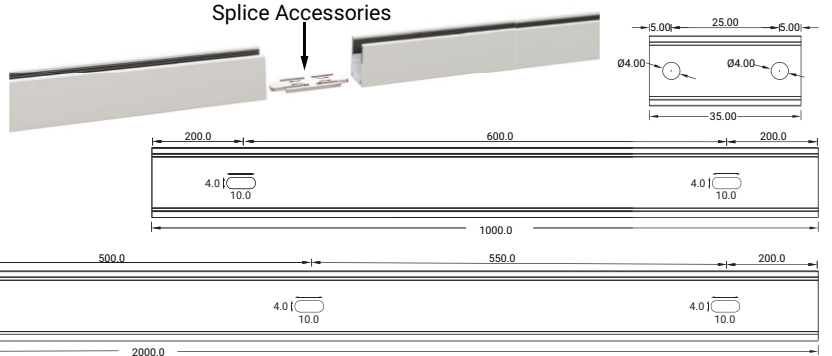

Model	W x H (mm)	Standard Length	Screw Holes	Holes Numbers
ALC16S08-035	22.00 x 20.80	35mm	Ø4.00mm	2
ALC16S08-100		1000mm	4.00mm	2
ALC16S08-200		2000mm	4.00mm	4

# LFX NEON SERIES 17 SPEC SHEET

LFX-N-17 -MONO-24V

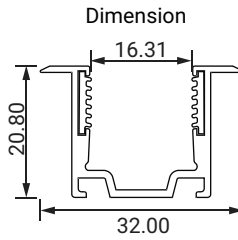

**Installation Way**

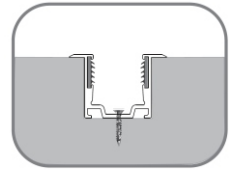

**Recessed**

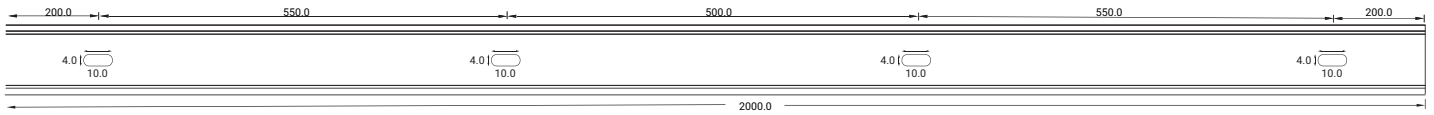
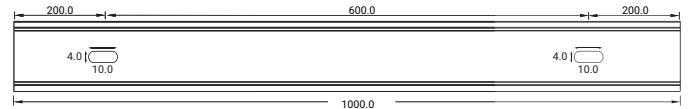
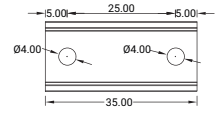

Model	W x H (mm)	Standard Length	Screw Holes	Holes Numbers
ALC16S07-035	32.00 x 20.80	35mm	Ø4.00mm	2
ALC16S07-100		1000mm	4.00mm	2
ALC16S07-200		2000mm	4.00mm	4



**Dimension**

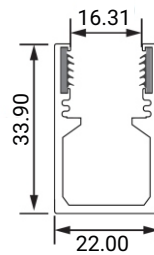

**Installation Way**

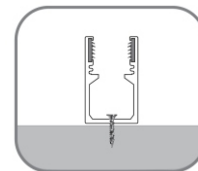

**Surface Mounted**

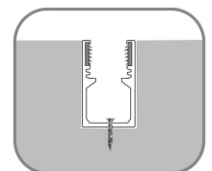

**Recessed**

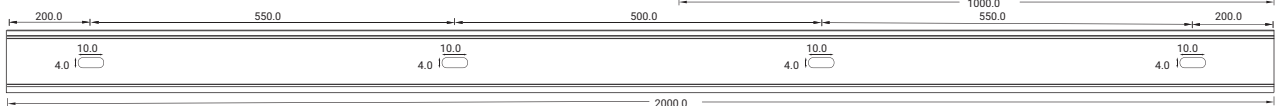
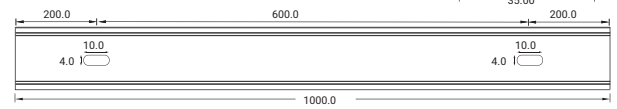
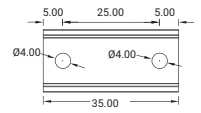

Model	W x H (mm)	Standard Length	Screw Holes	Holes Numbers
ALC16H02-035	22.00 x 33.90	35mm	Ø4.00mm	2
ALC16H02-100		1000mm	4.00mm	2
ALC16H02-200		2000mm	4.00mm	4



# LFX NEON SERIES 17 SPEC SHEET

LFX-N-17 -MONO-24V



## FLEXIBLE ALUMINUM CHANNEL

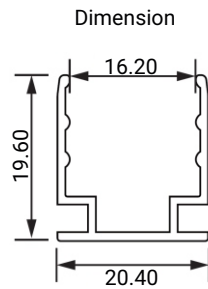
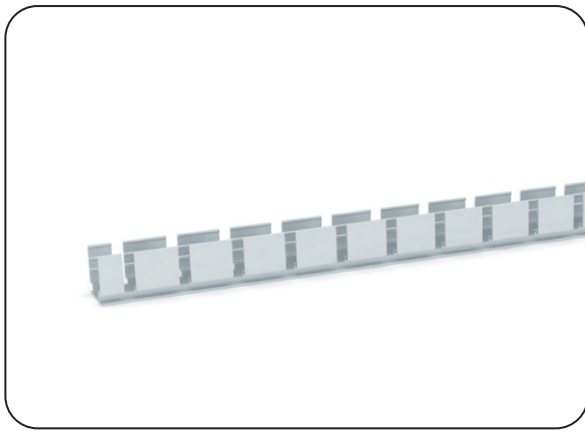

**Installation Way**

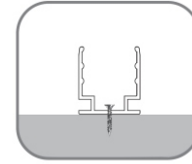

Surface Mounted

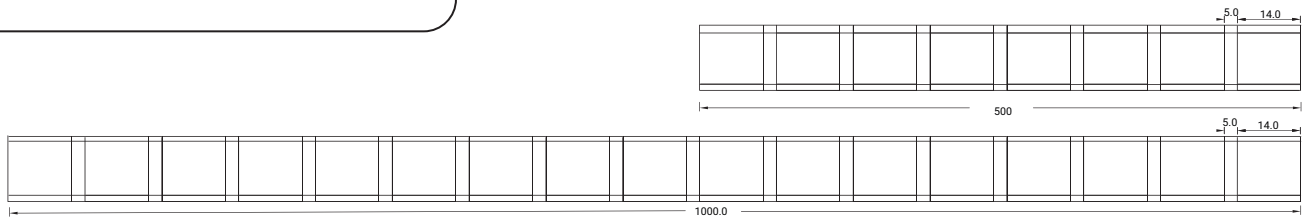

Model	W x H (mm)	Standard Length
ALC17S02FLX05	20.40 x 19.60	500mm
ALC17S02FLX10		1000mm

## PLASTIC CHANNEL

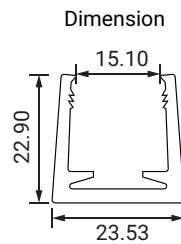

**Installation Way**

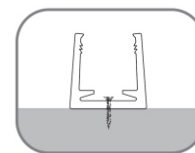

Surface Mounted

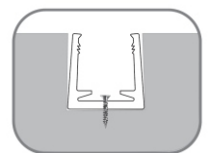

Recessed

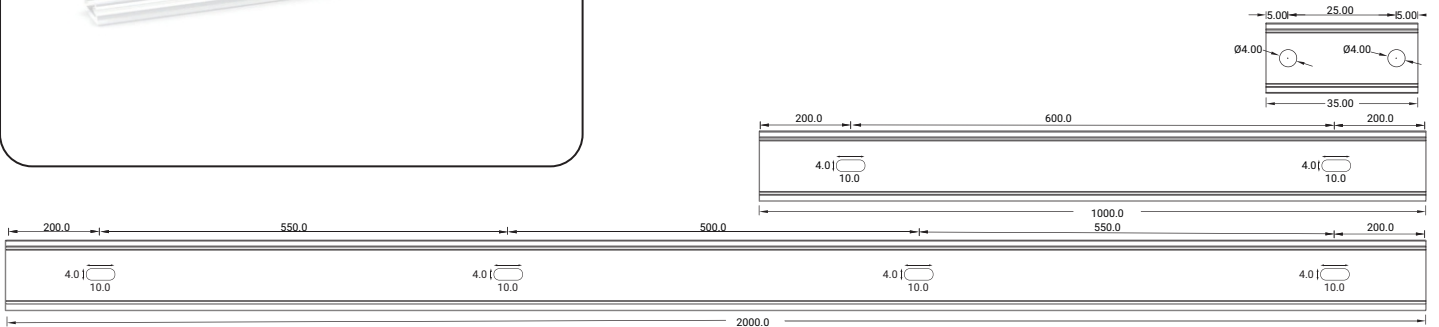

Model	W x H (mm)	Standard Length	Screw Holes	Holes Numbers
PC16/17S02-T-100	23.53 x 22.90	1000mm	Ø4.0mm	2

# LFX NEON SERIES 17 SPEC SHEET

LFX-N-17 -MONO-24V

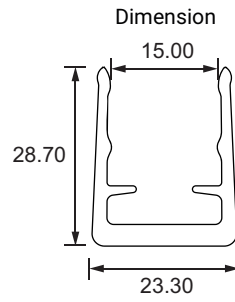

Installation Way

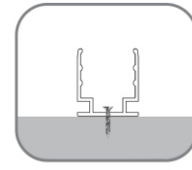

Surface Mounted

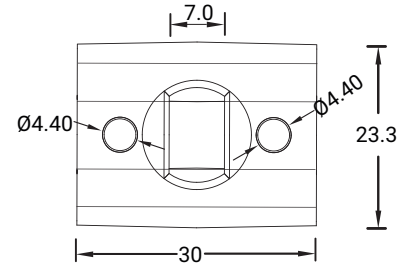

Model	W x H (mm)	Standard Length	Screw Holes	Holes Numbers
SJJ-ZSH-008-PC	23.30 x 28.70	30mm	Ø4.40mm	2

## STAINLESS STEEL CHANNEL

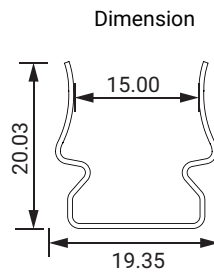
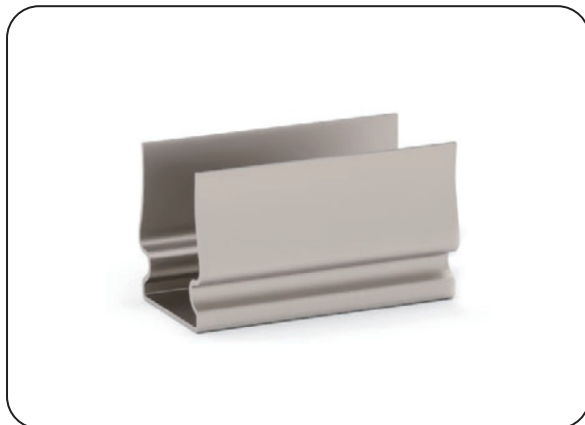

Installation Way

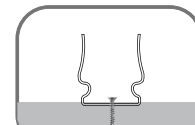

Surface Mounted

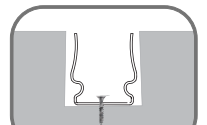

Recessed

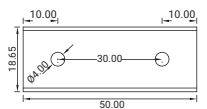

Model	W x H (mm)	Standard Length	Screw Holes	Holes Numbers
SSC16S01-05	19.35 x 20.03	50mm	Ø4.0mm	2

# LFX NEON SERIES 17 SPEC SHEET

LFX-N-17 -MONO-24V

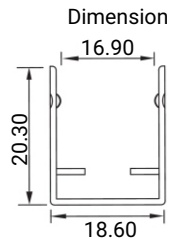
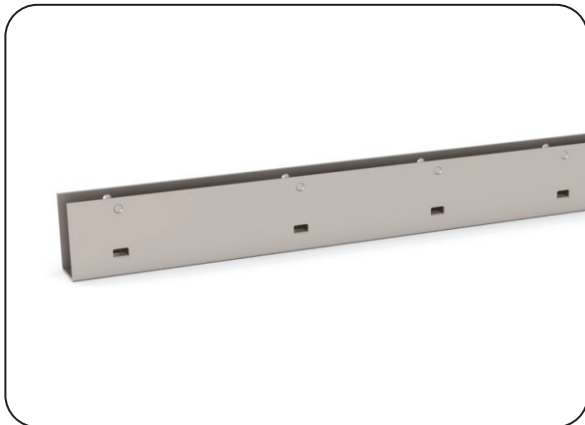

Installation Way

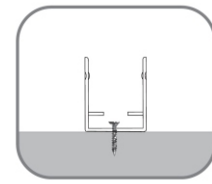

Surface Mounted

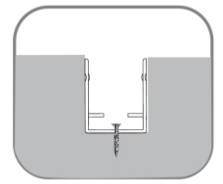

Recessed

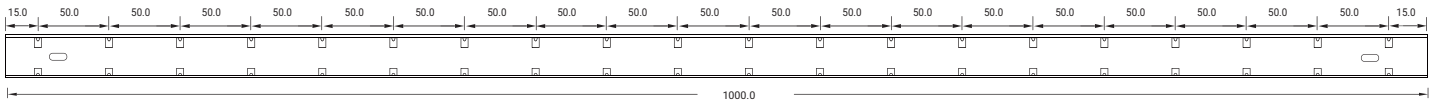

Model	W x H (mm)	Standard Length	Screw Holes	Holes Numbers
SSC16S02-100	18.60 x 20.30	1000mm	4.0 x 10mm	2

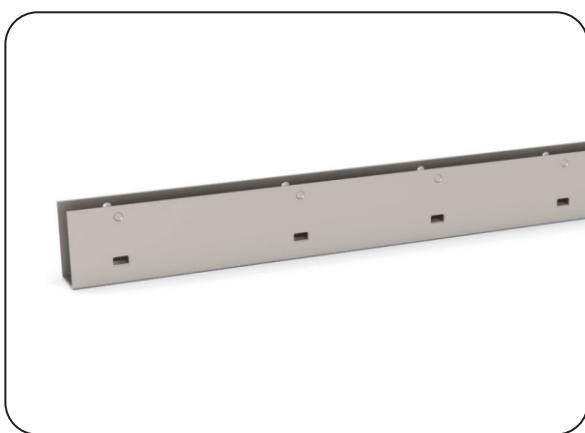

Dimension

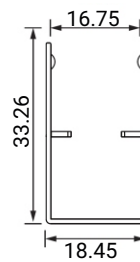

Installation Way

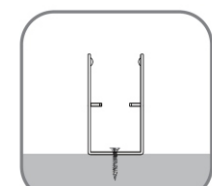

Surface Mounted

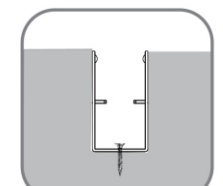

Recessed

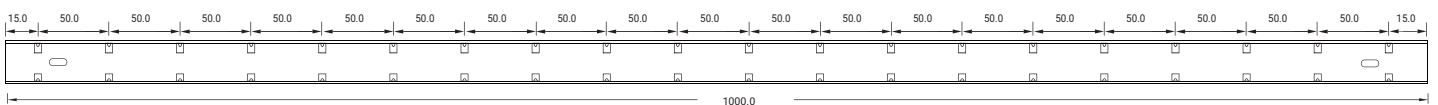

Model	W x H (mm)	Standard Length	Screw Holes	Holes Numbers
SSC16H01-100	18.45 x 33.26	1000mm	4.0 x 10mm	2

# LFX NEON SERIES 17 SPEC SHEET

LFX-N-17 -MONO-24V

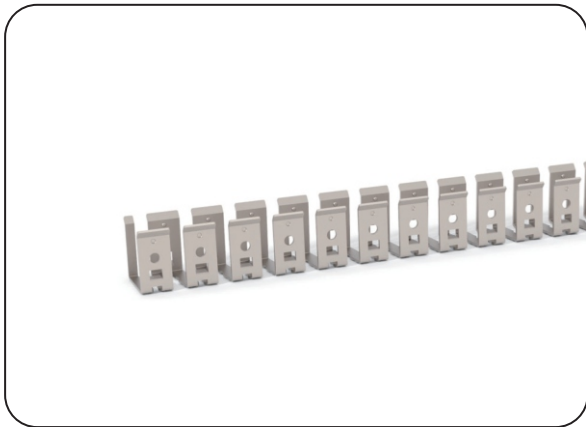

Dimension

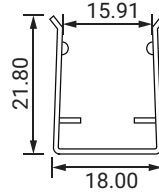

Installation Way

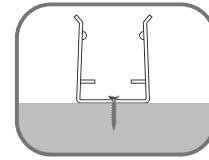

Surface Mounted

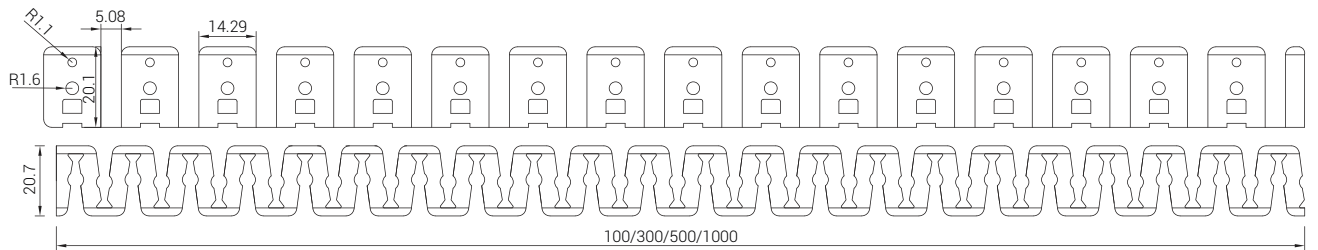

Model	W x H (mm)	Standard Length
SSC16FLX01	18.00 x 21.80	100mm
SSC16FLX03		300mm
SSC16FLX05		500mm
SSC16FLX10		1000mm