

# LED FLOOD LIGHT SQUARE SPEC SHEET



## LFL-Q-212S RGBW



The LFL-Q-212S RGBW offers a versatile lighting solution with its 8.35" x 8.35" (212 mm x 212 mm) modular lens, providing a range of available angles for various applications. Its minimalist exterior design ensures ease of construction and installation. With exceptional flexibility and scalability, the LFL-Q is well-suited for a wide array of environments while maintaining reliable performance.

### SPECIFICATION

<b>OPERATING VOLTAGE</b>	120-220V AC
<b>RATED POWER</b>	90W
<b>LEAKAGE CURRENT</b>	Max 0.7mA
<b>DOWN-LEAD SPEC</b>	3*1mm <sup>2</sup> Ø7.2mm + 4*0.3mm <sup>2</sup> Ø6.8mm (L=350mm)
<b>CONTROL</b>	DMX512
<b>CHANNELS</b>	1/4
<b>CONTROL CHIP</b>	UCS512D
<b>ADDRESSING</b>	Signal Cable Data A / Data B
<b>LIGHT SOURCE</b>	XUYULED
<b>NO OF LED</b>	24
<b>COLOR</b>	RGBW 4in1
<b>BEAM ANGLE</b>	15°, 30°, 45°, 60°, 15X60°
<b>LUMEN RANGE</b>	35 to 40 lm/W
<b>CRI</b>	≥80
<b>MATERIAL</b>	ADC12 Aluminum
<b>COLOR FINISH</b>	Black, grey, white
<b>ROTATION ANGLE</b>	180°
<b>DIMENSIONS</b>	8.35" x 4.96" x 11.28" (212 mm x 126 mm x 286.4 mm)
<b>NET WEIGHT</b>	3.1 kg
<b>LENS</b>	PC
<b>OPERATING TEMPERATURE</b>	-30°C to +50°C
<b>STORAGE TEMPERATURE</b>	-40°C to +80°C
<b>AVAILABLE IP RATING</b>	IP66
<b>IMPACT RATING</b>	IK07



**V** 120-220V AC  
Operating Voltage

**W** 90W  
Rated power

### ORDERING CODE

PRODUCT SERIES	TYPE	SIZE	POWER	COLOR TEMPERATURE	BEAM ANGLE	FIXTURE FINISHING	VOLTAGE	ACCESSORIES
LFL - LED Flood Light	Q - Square	212S	90W - 90 Watts	RGBW - RGBW	15D - 15°	BK - Black	AC - 120-220V AC	N - None
					30D - 30°	GY - Grey		H - Hood
					45D - 45°	WH - White		
					60D - 60°	XX - Custom*		
					15x60D - 15x60°			

Sample: LFL-Q-212S-90W-RGBW-15D-BK-AC-H

"\*" represent special order, please contact factory for detail.

### Expansion Setup



# LED FLOOD LIGHT SQUARE SPEC SHEET

LFL-Q-212S MONO



## DIMENSIONS

**LFL-Q-212S**  
Net Weight: 3.1 kg

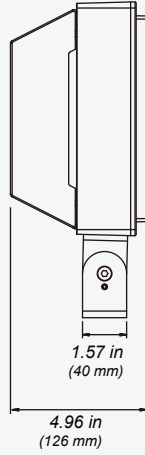
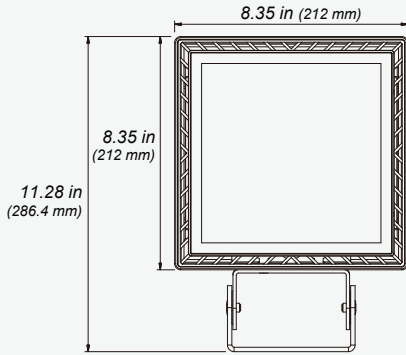

**Visor  
(Optional)**

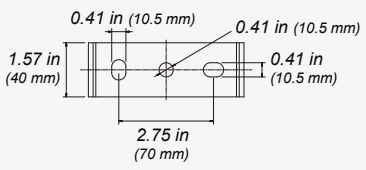
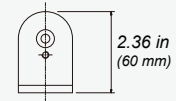
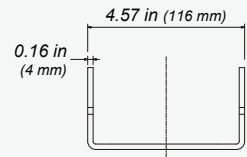
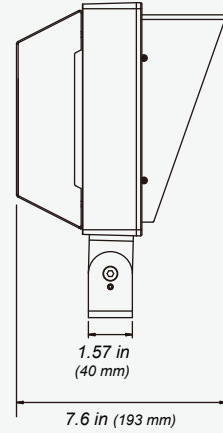

## PHOTOMETRIC DATA

**8 Degrees**

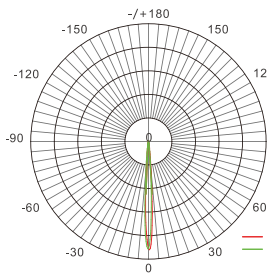

**15 Degrees**

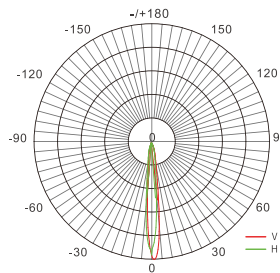

**30 Degrees**

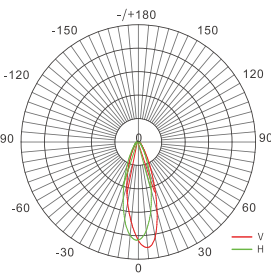

**45 Degrees**

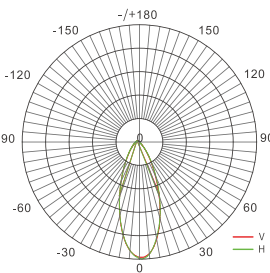

**60 Degrees**

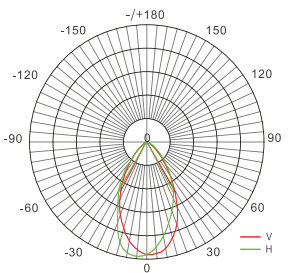

**15x60 Degrees**

