

LINEAR FIXTURE TRACK - SPOT SPEC SHEET



LFT60-S



The LFT60-S Series is a range of spotlight solution ideal for galleries or focus lighting on specific subject or wall. With its wide range of track mounting options, the LFT60-S are compatible with recessed, surface and suspended pendant mounting. The series is equipped with dimming and standard color temperature of 3000K. With the versatility of 355-degree rotation and 90-degree tilt angle, the LFT60-S Series can direct its light to almost any direction. The LFT60-S4 in particular has one light engine with a power rating of 44 Watts and has three beam angles options.



LFT60-S4

SPECIFICATIONS

OPERATING VOLTAGE	120 VAC
RATED POWER	44W
CONTROL	0/1-10 V Dimmable
FLUX	3050 lm
CRI	>90
BODY FINISH	Black, White
BAFFLE FINISH	Black, White, Copper
MOUNTING	Track mounted
PROJECTION	17°, 21°, 35°
ROTATION	355°
TILT ANGLE	90°

V 120 VAC
Operating Voltage

W 44W
Rated Power

DIMENSIONS

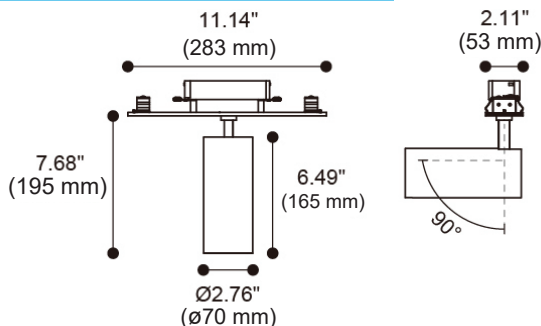

ORDERING CODE

SERIES	TYPE	POWER	VOLTAGE	CRI	COLOR TEMPERATURE	PROJECTION	TRACK MOUNTING	BODY FINISH	BAFFLE FINISH
LFT60	S4 - Spot 4	44W - 44 WATTS	AC - 120VAC	90 - CRI90	CT30 - 3000K	17D - 17 Degrees	RM - Recessed Mount	BK - Black	BK - Black
					CTXX - CUSTOM	21D - 21 Degrees	SM - Surface Mount	WH - White	WH - White
						35D - 35 Degrees	PM - Pendant Mount		CO - Copper

Sample: LFT 60-S4 - 44W- AC - 90 - CT30 - 21D - SM - BK - CO - ACHO-13

ACCESSORIES

S17-1	-	Long Snoot
ACSG-8	-	Striped Glass
ACHO-13	-	Honeycomb Louver
ACWG-9	-	Woven Glass

PHOTOMETRIC DATA

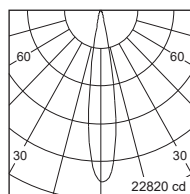

BEAM ANGLE: 17°
MAX. I: 22820 cd.
FLUX: 3050 lm

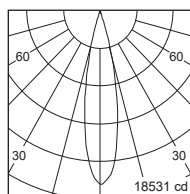

BEAM ANGLE: 21°
MAX. I: 18531 cd.
FLUX: 3050 lm

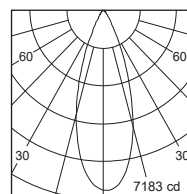

BEAM ANGLE: 35°
MAX. I: 7183 cd.
FLUX: 3050 lm

LINEAR FIXTURE TRACK - MOUNTING & ACCESSORIES



LFT60-S

MOUNTING OPTIONS

TRIMLESS: LFT-T-11

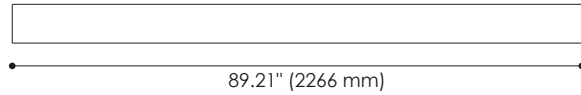
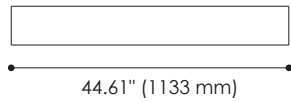
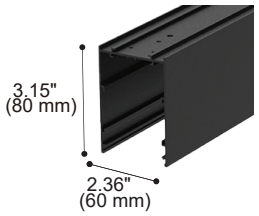

TRIMLESS TRACK SECTION	
Article number	TYPE
LFT-T-11-44	Channel
LFT-T-11-89	Channel

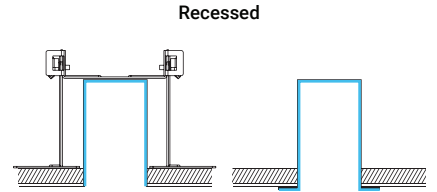

TRIM: LFT-F-11

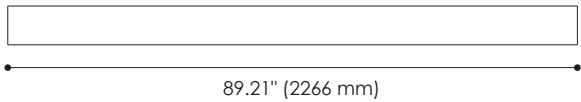
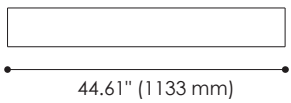
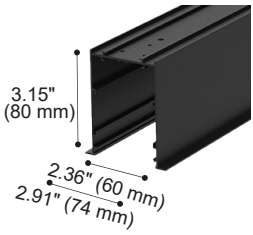

TRIMMED TRACK SECTION	
Article number	TYPE
LFT-F-11-44	Channel
LFT-F-11-89	Channel

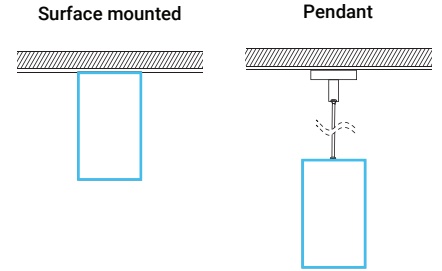

ACCESSORIES

ALL MODELS

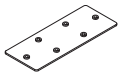
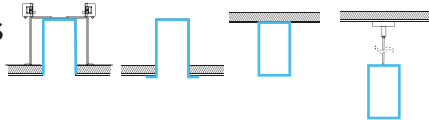

3PCS

SKU : LFT-NC-02
Type : Surface mounted & Pendant reinforced plate

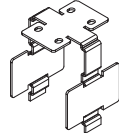

SKU : LFT-NC-07
Type : Light Leak-proof aluminium extrusion reinforce plate



Colours
Black White

SKU :
LFT-NE-02-11 11.14" (283 mm)
LFT-NE-02-22 22.28" (566 mm)
Type : Blank cover



SKU : LFT-SA-41
Type : Power cord connector



SKU : LFT-PA-41-180
71" (1800 mm)
Type : Power cord connect to AC



SKU : LFT-SA-41-30 12" (300 mm)
LFT-SA-41-60 24" (600 mm)
Type : Power cord connect between modules

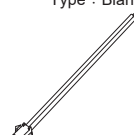

SKU : LFT-PSA-31-180 71" (1800 mm)
Type : Signal wire connect to system / dimmer

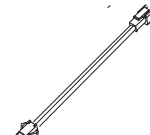

SKU : LFT-SSA-31-30 12" (300 mm)
LFT-SSA-31-60 24" (600 mm)
Type : Signal wire connect between modules

PENDANT

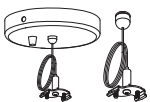
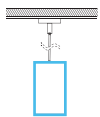

SKU : LFT-DI-15
Type : Pendant Kit for power connection (without power cord)

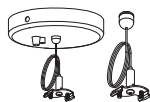

SKU : LFT-DI-15-V
Type : Pendant Kit for power connection (without power cord and single wire)



SKU : LFT-DI-16
Type : Pendant kit

TRIM

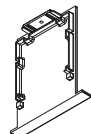
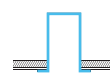

2PCS

SKU : LFT-NC-05
Type : Trim end cap

TRIMLESS

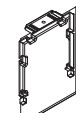
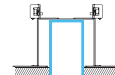

2PCS

SKU : LFT-NC-03
Type : End cap

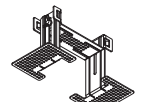

2PCS

SKU : LFT-NR-01
Type : Trimless bracket