

# LFX NEON SERIES

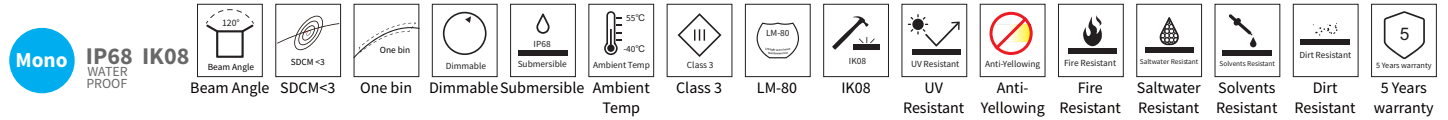

## LFX-1717-HB (Horizontal Bending Version)



YYZ LFX Neon series is designed to provide a very bright, crisp consistent and homogenized illumination that will accentuate any building, structure, or artistic flourish. Using high brightness surface mounted LEDs, behind a first-class eco-friendly UV-resistant Silicone polymer encapsulated flexible chamber material, the LFX Neon will provide your project with bright, consistent traces of light in in shades of White, single colors. The fixture consists of uniform and even lighting with no LED hotspot. LFX Neon has a transverse minimum radius of 150mm and is horizontal bendable. Easy to install, can be cut and reconnected with IP68 protected connector. The product is supplied in 5m standard rolls or custom as needed.

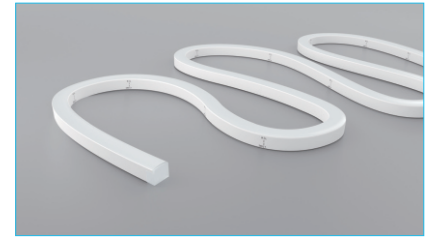

### FEATURES

|                       |  |
|-----------------------|--|
| LIGHT SOURCE          | LumiLEDs SMD LED 2835                          |
| WORKING VOLTAGE       | DC 24V   |
| RATED POWER           | 10W/m  |
| LED QUANTITY          | 120 Leds / m                                   |
| RADIANCE ANGLE        | 120°   |
| LAMP LIFE             | 70,000 Hours L70@25°C<br>50,000 Hours L70@50°C |
| MOUNTING              | Mounting clip / chanel                         |
| CONNECTION            | Outdoor rated connections                      |
| CUTTING INCREMENTS    | 100mm (1 Unit, 12LEDs)                         |
| MINIMUM BEND DIAMETER | 150mm  |
| DIMENSIONS            | 16.5mm(W) x 16.5mm(H)                          |
| OPERATING TEMP        | -40° C - +55° C                                |
| STORAGE TEMP          | -20° C - +55° C                                |
| CONTINUOUS LENGTH     | 5mtr   |
| DIMMING               | Non dim, Dali                                  |
| IP RATING             | IP68 Wet location submersible <2m              |

- LUMILEDS LED Quality
- 24 V DC Working Voltage
- 10W/m Rated power

### ELECTRICAL DATA

|                   |  |
|-------------------|--|
| POWER CONSUMPTION | 10W/m                                    |
| SUPPLY VOLTAGE    | DC 24 V                                  |
| COLORS            | 2700K, 2800K, 3000K, 4000K, 5000K, 6000K |
| CRI               | 80, 90                                   |

### ORDERING LOGIC

| PRODUCT     | POWER     | COLOR TEMPEARATURE | CRI     |
|-------------|-----------|--------------------|---------|
| LFX 1717-HB | 10 - 10 W | (CT 27) - 2700K    | 80 - 80 |
|             |           | (CT 28) - 2800K    | 90 - 90 |
|             |           | (CT 30) - 3000K    |         |
|             |           | (CT 40) - 4000K    |         |
|             |           | (CT 50) - 5000K    |         |
|             |           | (CT 60) - 6000K    |         |

Sample: LFX 1717-HB - 10 - CT27 - 80

### LUMEN CHART

| White         | Lumen Output |
|---------------|--------------|
| 2700K (CT 27) | 410lm/m      |
| 2800K (CT 28) | 414lm/m      |
| 3000K (CT 30) | 420lm/m      |
| 4000K (CT 40) | 430lm/m      |
| 5000K (CT 50) | 420lm/m      |
| 6000K (CT 60) | 415lm/m      |

# LFX NEON SERIES

LFX-1717-HB (Horizontal Bending Version)

## BENDING DETAILS

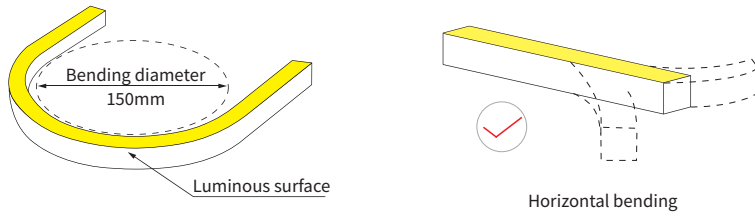

## DIMENSION

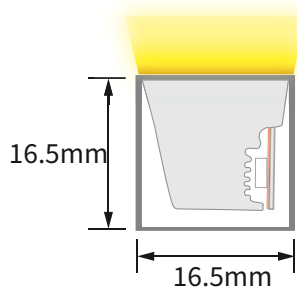

## ACCESSORIES

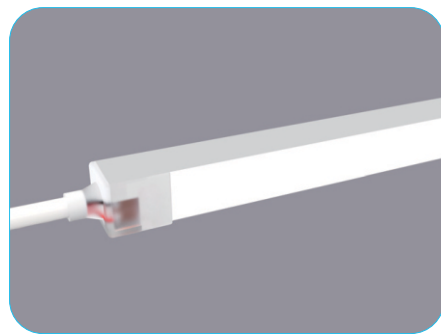

Direct Entry Connector  
YYZ-MIC-DEC-01 (Single Feed-Right Side)  
YYZ-MIC-DEC-02 (Single Feed-Left Side)  
YYZ-MIC-DEC-03 (Double Feed-Both Side)

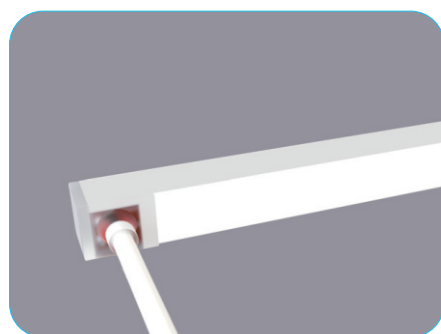
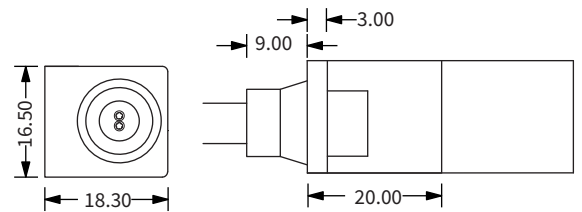

Side Entry Connector  
YYZ-MIC-SEC-01 (Single Feed-Right Side)  
YYZ-MIC-SEC-02 (Single Feed-Left Side)  
YYZ-MIC-SEC-03 (Double Feed-Both Side)

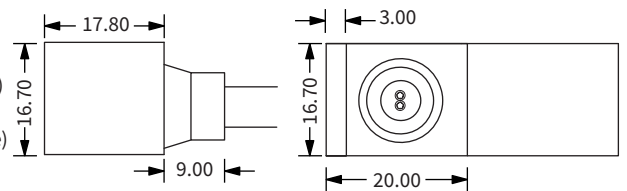

Bottom Entry Connector  
YYZ-MIC-BEC-01 (Single Feed-Right Side)  
YYZ-MIC-BEC-02 (Single Feed-Left Side)  
YYZ-MIC-BEC-03 (Double Feed-Both Side)

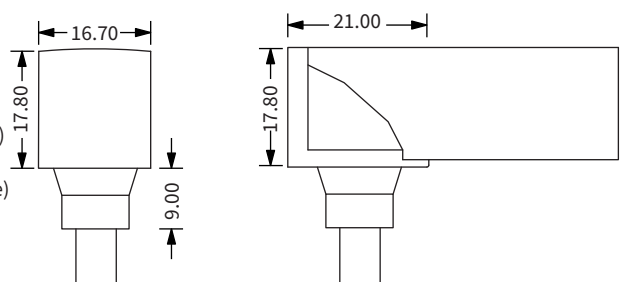

# LFX NEON SERIES

LFX-1717-HB (Horizontal Bending Version)

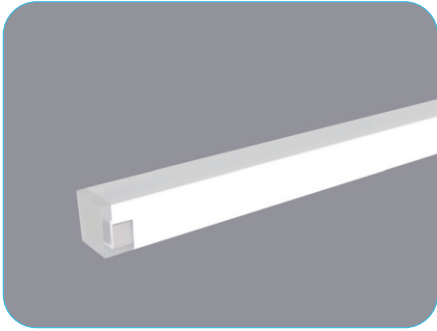

End Cap  
YYZ-EC

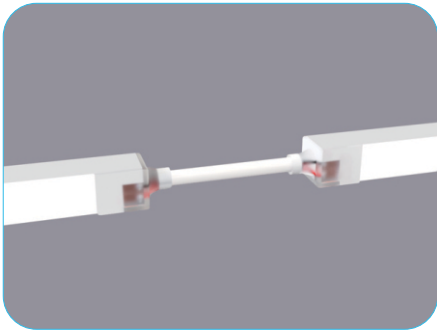
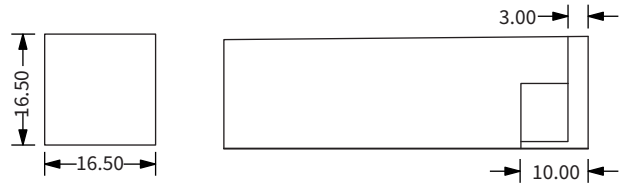

Jumper  
YYZ-JC

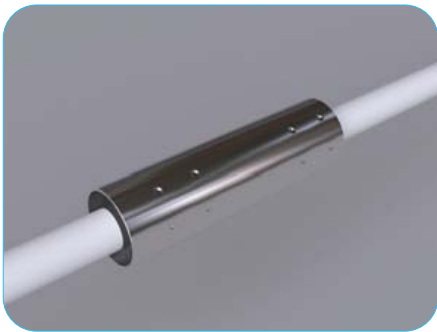
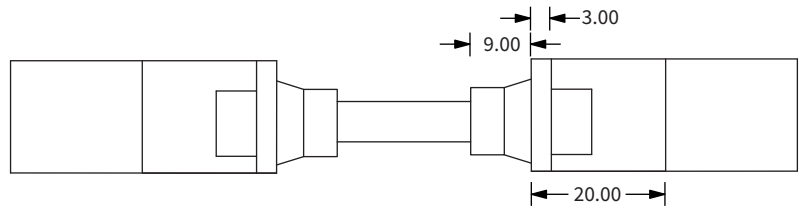

Waterproof interrupter  
YYZ-WP-I

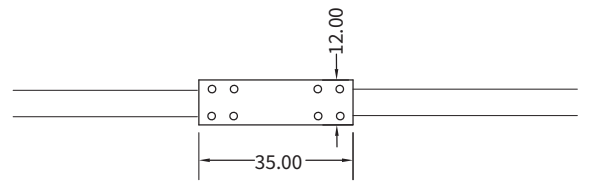

Male Connector  
YYZ-MC

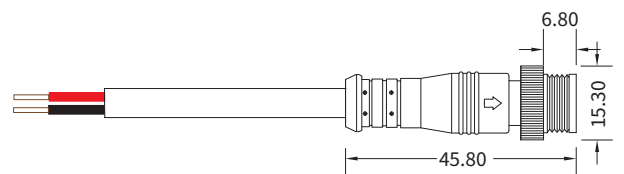

Female Connector  
YYZ-FC

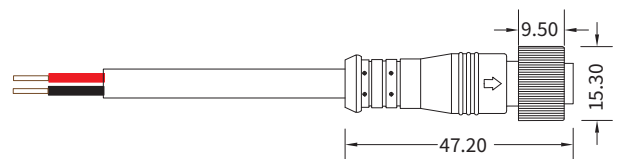

# LFX NEON SERIES

## LFX-1717-HB (Horizontal Bending Version)



### ALUMINIUM CHANNEL

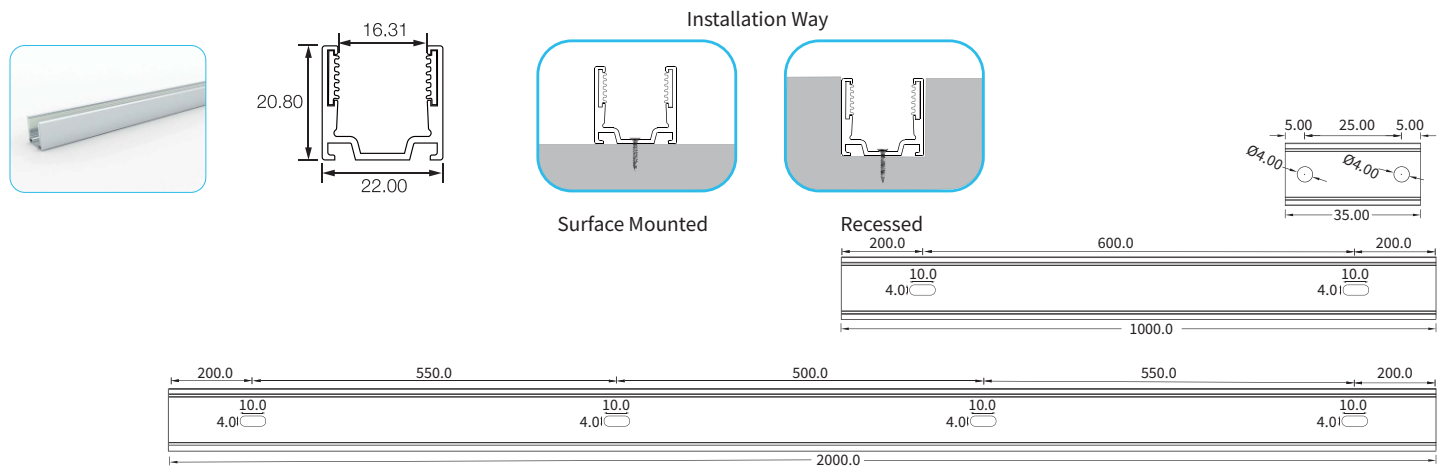

| Model                       | W x H (mm)    | Standard Length | Screw Holes | Holes Numbers |
|-----------------------------|---------------|-----------------|-------------|---------------|
| YYZ-AC-1-35-4-2-LFX-17-HB   | 22.00 x 20.80 | 35mm            | Ø4.0mm      | 2             |
| YYZ-AC-1-1000-4-2-LFX-17-HB |               | 1000mm          | 4.0mm       | 2             |
| YYZ-AC-1-2000-4-4-LFX-17-HB |               | 2000mm          | 4.0mm       | 4             |

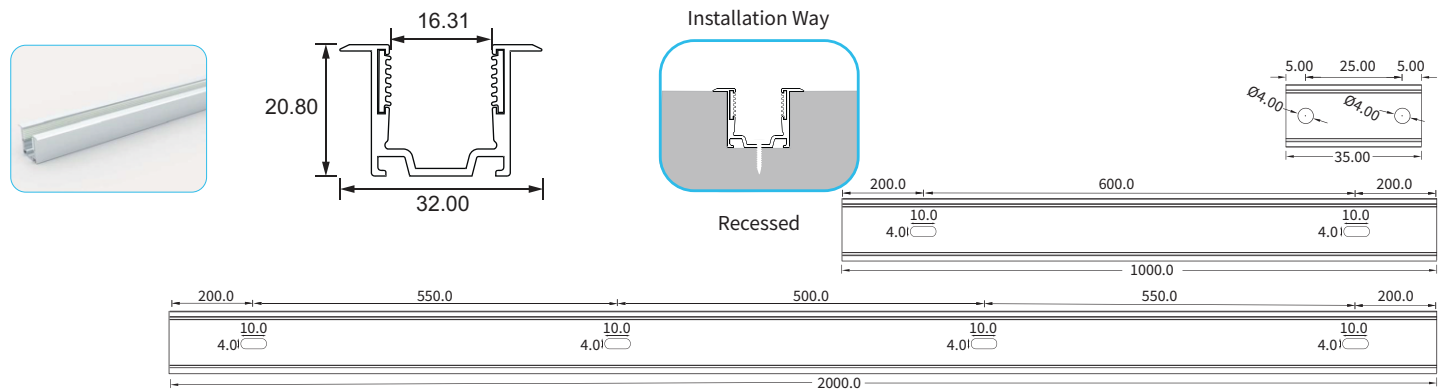

| Model                       | W x H (mm)    | Standard Length | Screw Holes | Holes Numbers |
|-----------------------------|---------------|-----------------|-------------|---------------|
| YYZ-AC-2-35-4-2-LFX-17-HB   | 22.00 x 22.80 | 35mm            | Ø4.0mm      | 2             |
| YYZ-AC-2-1000-4-2-LFX-17-HB |               | 1000mm          | 4.0mm       | 2             |
| YYZ-AC-2-2000-4-4-LFX-17-HB |               | 2000mm          | 4.0mm       | 4             |

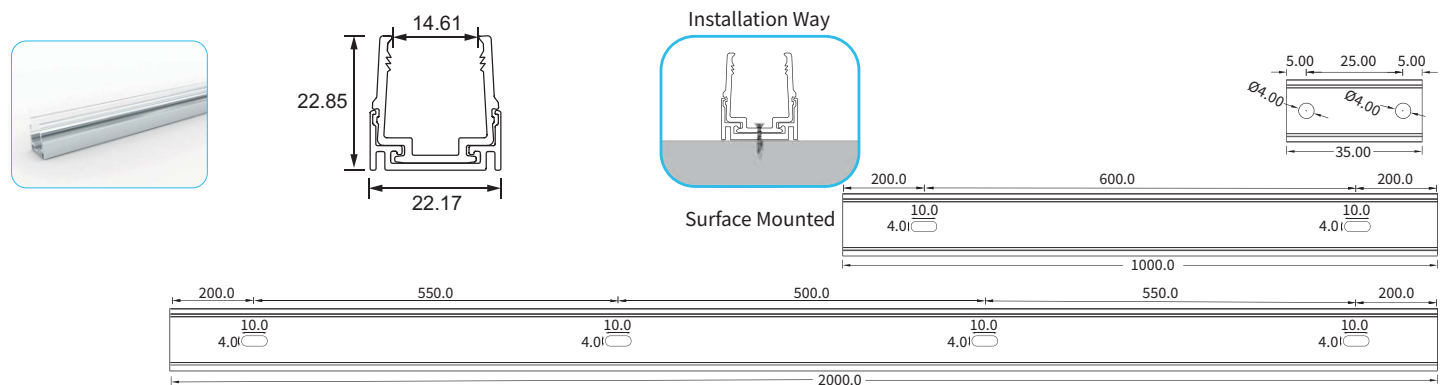

| Model                       | W x H (mm)    | Standard Length | Screw Holes | Holes Numbers |
|-----------------------------|---------------|-----------------|-------------|---------------|
| YYZ-AC-3-35-4-2-LFX-17-HB   | 22.17 x 22.85 | 35mm            | Ø4.0mm      | 2             |
| YYZ-AC-3-1000-4-2-LFX-17-HB |               | 1000mm          | 4.0mm       | 2             |
| YYZ-AC-3-2000-4-4-LFX-17-HB |               | 2000mm          | 4.0mm       | 4             |

# LFX NEON SERIES

LFX-1717-HB (Horizontal Bending Version)



## STAINLESS STEEL CHANNEL

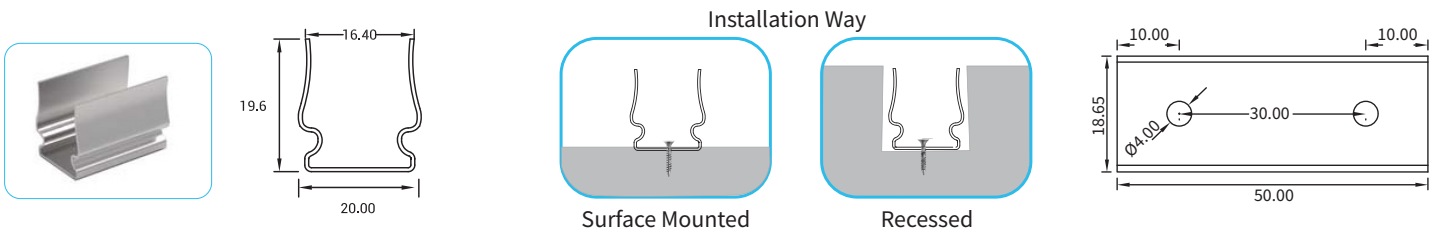

| Model                   | W x H (mm)  | Standard Length | Screw Holes          | Holes Numbers |
|-------------------------|-------------|-----------------|----------------------|---------------|
| YYZ-SSC-50-4-2-LFX-17HB | 20.0 x 19.6 | 50mm            | $\varnothing 4.0$ mm | 2             |

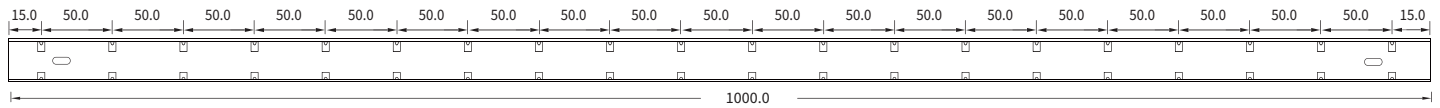
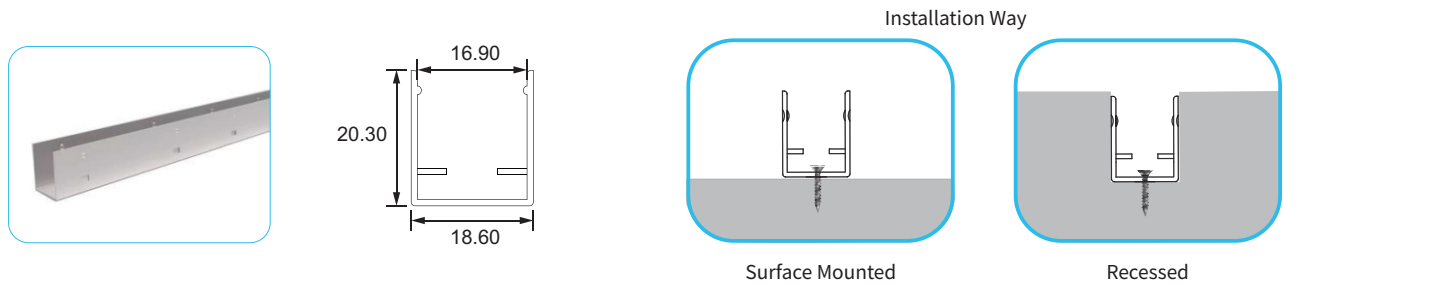

| Model                         | W x H (mm)    | Standard Length | Screw Holes                | Holes Numbers |
|-------------------------------|---------------|-----------------|----------------------------|---------------|
| YYZ-SSC-1000-4x10-2-LFX-17-HB | 18.60 x 20.30 | 1000mm          | $\square 4.0 \times 10$ mm | 2             |

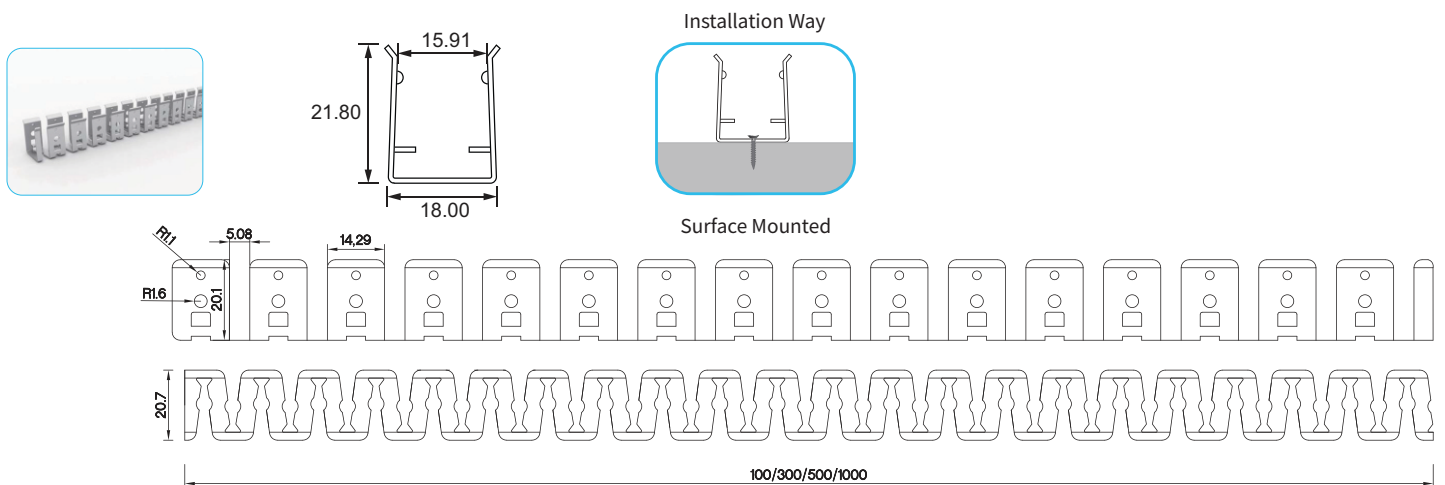

| Model                      | W x H (mm)    | Standard Length |
|----------------------------|---------------|-----------------|
| YYZ-SSC-FLX-100-LFX-17-HB  | 18.00 x 21.80 | 100mm           |
| YYZ-SSC-FLX-300-LFX-17-HB  |               | 300mm           |
| YYZ-SSC-FLX-500-LFX-17-HB  |               | 500mm           |
| YYZ-SSC-FLX-1000-LFX-17-HB |               | 1000mm          |