

OPERA GENERAL DOWNLIGHT

OPAGL 85

Mono IP20/IP44 **CE**

YYZ Opera general downlight series are best suited for architectural in addition to general lighting since it enables symmetrical light distribution to get an effective task, accent or general lighting. Wide range of wattage options from 7W to 42W are available making it versatile for applications with mounting heights from 2.8m to 10m. It has carefully designed optics that ensure UGR<19 even with ultra-wide distribution.

FEATURES

MATERIAL	Aluminum
FINISH	White, Black
RATED POWER	10/15W
WORKING VOLTAGE	220-240V 50/60Hz
RADIANCE ANGLE	Wide, Ultra wide
MOUNTING	Ceiling recessed
CONNECTION	Indoor rated connections
LAMP LIFE	50,000 Hrs
DIMENSION	Ø85x100mm(CutoutØ75mm)
OPERATING TEMP	-20° C - +50° C
CONTROL	On/Off, Triac, 1-10V, Dali



LUMILEDS/CITIZEN
LED Quality

240 VOLTS
Working Voltage

10/15W
Rated power

ELECTRICAL DATA

POWER CONSUMPTION	10/15W
SUPPLY VOLTAGE	220-240V AC
COLORS	2700K, 3000K, 3500K, 4000K
CRI	90+, SDCM<3
LUMEN	90lm/W

DIMENSIONS

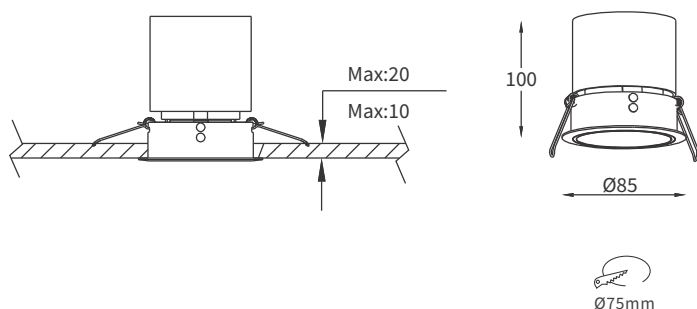

Linear Spread Lens

Spread Lens

ORDERING LOGIC

PRODUCT	WATTAGE	COLOR TEMPERATURE	CONTROL	VOLTAGE	BEAM ANGLE	FINISH	ACCESSORIES	IP RATING	
OPAGL 85	10 - 10W	(CT27)	2700K	ON/OFF	240VAC	W - Wide	LSL - Linear Spread Lens	IP20	
	15 - 15W	(CT30)	3000K	TRIAC		U - Ultra Wide	WH - White	SL - Spread Lens	IP44
		(CT35)	3500K	1-10V					
		(CT40)	4000K	DALI					

Sample: OPAGL 85 - 10 - CT27 - ON/OFF - 240 - W - BL - LSL - IP20