

HOLDER

HLD-SQ25

Mono IP20 CE

YYZ Holder Square series are miniature downlights in square profile with choice of 1,2 to 5 lamps. These downlights are with symmetrical light distribution which help us to accurately orient towards illuminating objects. The finishes available have the light fitting heads in white and black.

FEATURES

MATERIAL	Aluminum
FINISH	White, Black
RATED POWER	5x5W
WORKING CURRENT	500mA
RADIANCE ANGLE	15°, 24°, 38°, 50°
MOUNTING	Ceiling recessed
CONNECTION	Indoor rated connections
LAMP LIFE	50,000 Hrs
DIMENSION	251 x 62 x 57mm (cutout 245x57mm)
OPERATING TEMP	-20° C - +50° C
CONTROL	On/Off, 1-10V, Dali



CITIZEN
LED Quality

500mA
Working Current

5x5W
Rated power

ELECTRICAL DATA

POWER CONSUMPTION	5x5W
SUPPLY VOLTAGE	220-240VAC
COLORS	2700K, 3000K, 4000K
CRI	90+
LUMEN	5x480 lm

DIMENSIONS

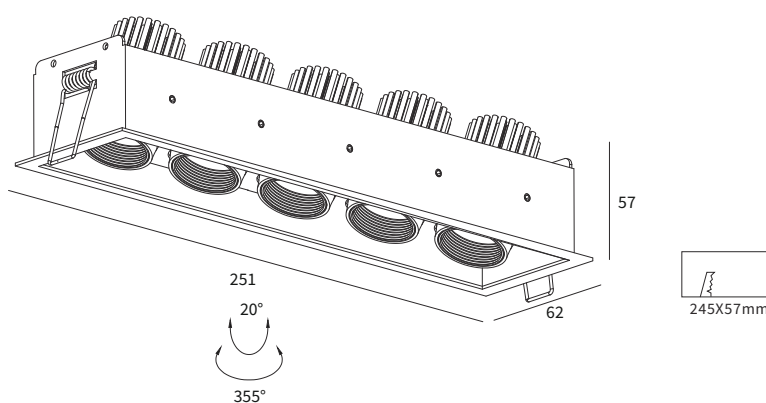

ORDERING LOGIC

PRODUCT	COLOR TEMPERATURE	WATTAGE	BEAM ANGLE	BODY FINISH	CUSTOM	
HLD-SQ25	(CT27)	2700K	25 - 5x5W	15 - 15°	BK - Black	XX - XXX
	(CT30)	3000K		24 - 24°	WH - White	
	(CT40)	4000K		38 - 38°		
				50 - 50°		

Sample: HLD-SQ25 - CT27 - 25 - 15 - BK - XX