

# MYRIAD TRACK LIGHT

## MRD

Mono IP20 CE

YYZ myriad track lights houses driver unit to the track adapter allowing better thermal performance and hence the light output.

Options of various optics on a 1-circuit, 3-circuit adapter with wide range of dimming options makes the system versatile.

### FEATURES

FINISH	BLACK, GREY, WHITE
WORKING VOLTAGE	220-240V 50/60Hz
RATED POWER	28/36W
RADIANCE ANGLE	NARROW, MEDIUM, WIDE, ULTRA WIDE
LAMP LIFE	50,000 HRS
MOUNTING	TRACK MOUNTED
CONNECTION	INDOOR RATED CONNECTIONS
DIMENSIONS	Ø90 x 188 x 212mm
OPERATION TEMP	-20° C - +50° C
CONTROL	ON/OFF, TRIAC, 1-10V, DALI

CITIZEN/LUMILEDS  
LED Quality

240 VOLTS  
Working Voltage

28/36 W  
Rated power



### ELECTRICAL DATA

POWER CONSUMPTION	28/36W
SUPPLY VOLTAGE	220-240VAC
COLORS	2700K, 3000K, 3500K, 4000K
CRI	90+
LUMEN	90lm/W

### DIMENSIONS

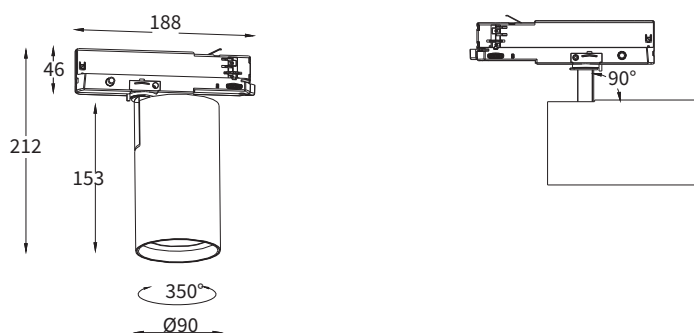

### ORDERING LOGIC

PRODUCT	CONTROL	WATTAGE	COLOR TEMPERATURE	VOLTAGE	BEAM ANGLE	FINISH	ACCESSORIES
MRD-28	ON/OFF	28 - 28W	(CT27) 2700K	240VAC	N - Narrow	BL - Black	HCL - Honey Combo Louver
MRD-36	TRIAC	36 - 36W	(CT30) 3000K		M - Medium	GR - Grey	LSL - Linear Spread Lens
	1-10V		(CT35) 3500K		W - Wide	WH - White	WWV - Wall Washer Visor
	DALI		(CT40) 4000K		UW- Ultra wide		SP - Spread Lens
							BD - Barn Doors

Sample: MRD-28 - ON/OFF - 28 - CT27 - 240 - N - BL - HCL - XX

Honeycomb 
 Linear spread lens 
 Wall washer visor 
 Spread lens 
 Barn doors